





waystar | koyco



**PRELIMINARY** 092217



<b>SUCCESSION</b>	Set Name: <b>INT. WAYSTAR EXECUTIVE LEVEL LOGAN'S OFFICE / ASS. &amp; CONFERENCE ROOM</b>		Set #: <b>207/211</b>	Released: ---
	Drawing: <b>Plan</b>		Scale: <b>1/16" = 1'-0"</b>	Sheet No:
	Location: <b>33rd FLOOR _ 7 WTC</b>		Date: <b>09/20/2017</b>	Drawn By: <b>AC</b>

[Drawing Title]  
Scale: 1/16" = 1'-0"

1

Alcon Lighting Beam 66 Series Arch 6 foot linear  
To be wired by Electricians with LED Tape x 24

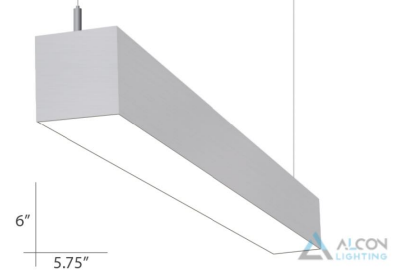

Alcon Lighting Beam 66 Series Arch 8 foot linear  
To be wired by Electricians with LED Tape x 2

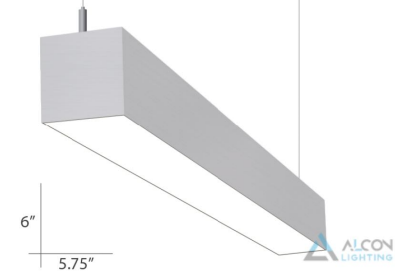

USAI Dimmable and Color Temperature Adjustable  
Recessed Square Downlight 8 units can gang on one dimmer pair x 49

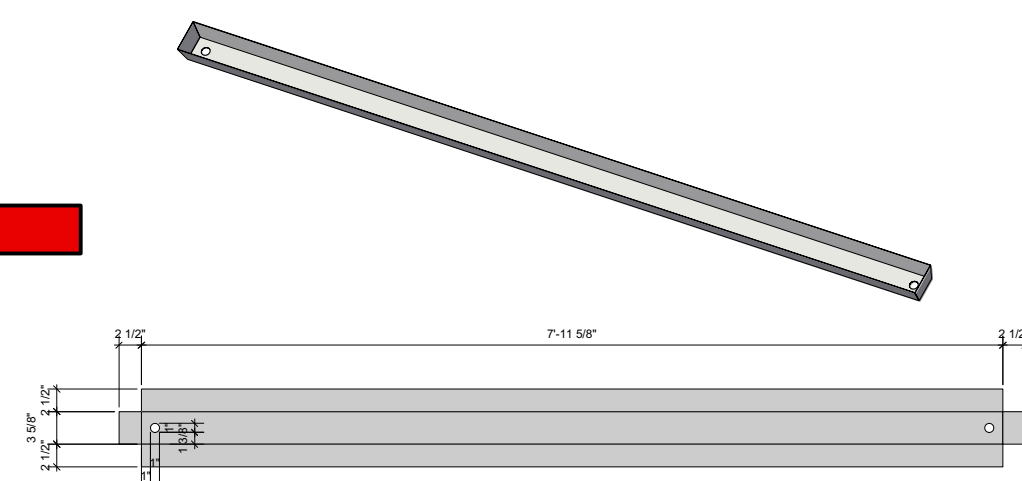

4 x 96 Milk Plexiglass Set into Our Hung Ceiling grid and covered with  
a bent metal box into which Electricians wire LED tape. x 20

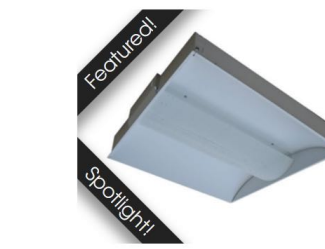
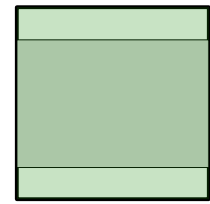
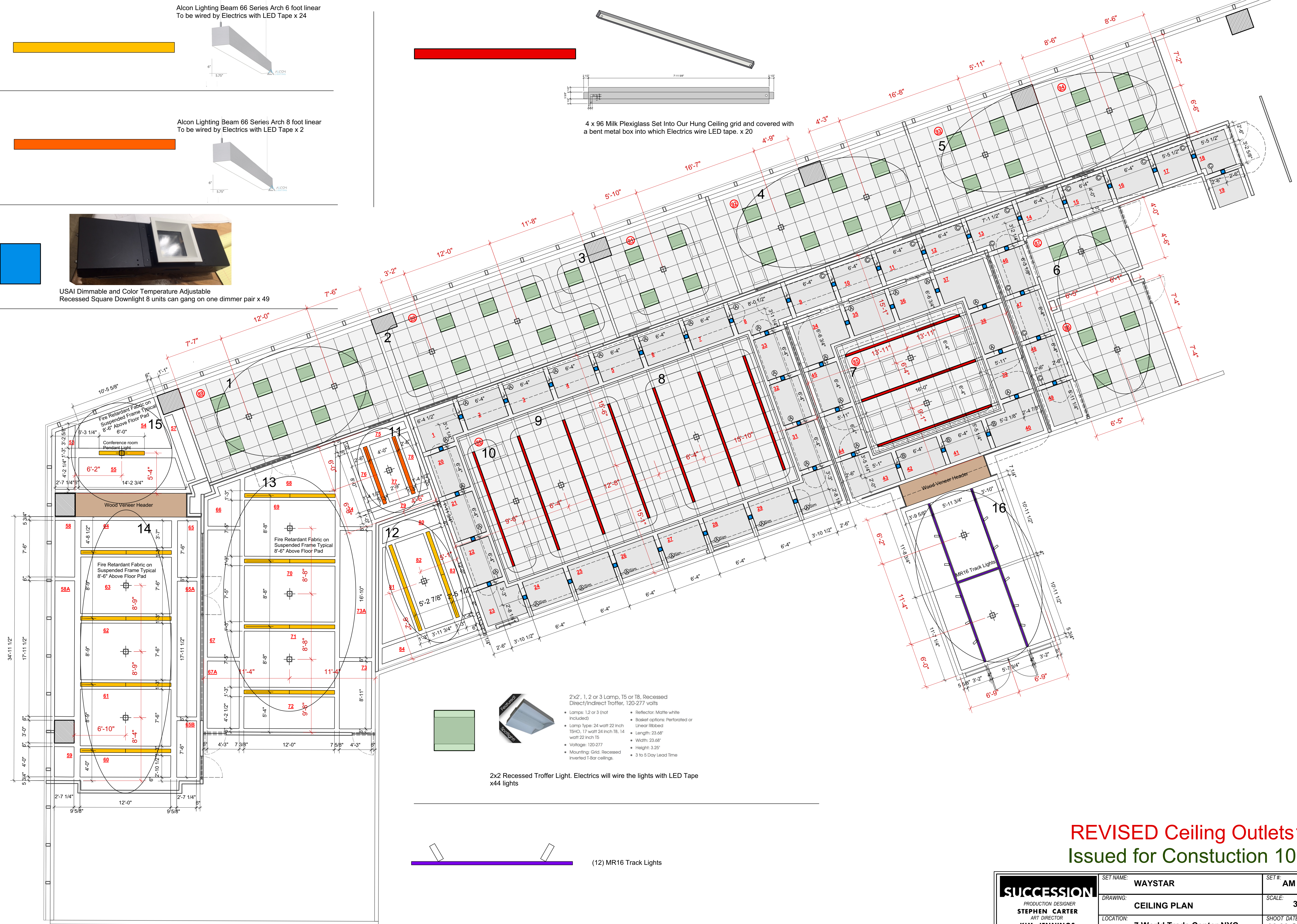

2x2 Recessed Troffer Light. Electricians will wire the lights with LED Tape  
x44 lights

- 2x2, 1, 2 or 3 Lamp, T5 or T8, Recessed Direct/Indirect Troffer, 120-277 volts (included)
- Lamp type: 24 watt 22 inch T8HO, 17 watt 24 inch T8, 14 watt 22 inch T5
- Voltage: 120-277
- Mounting: Grid, Recessed inverted T-Bar ceilings.
- Reflector: Matte white
- Scales options: Perforated or Linear Ribbed
- Length: 23.68"
- Width: 23.68"
- Height: 3.25"
- 3 to 5 Day Lead Time



(12) MR16 Track Lights

**REVISED Ceiling Outlets 11.07.17**  
Issued for Constuction 10.24.2017

<b>SUCCESSION</b> PRODUCTION DESIGNER <b>STEPHEN CARTER</b> ART DIRECTOR <b>KIM JENNINGS</b>	SET NAME: <b>WAYSTAR</b>	SET#: <b>AM 206-212</b>	RELEASED: <b>---</b>
	DRAWING: <b>CEILING PLAN</b>	SCALE: <b>3/16" = 1'-0"</b>	SHEET NO.:
	LOCATION: <b>7 World Trade Center NYC</b>	SHOOT DATE: <b>00.00.00</b>	DRAWN BY: <b>D</b>







**SUCCESSION**



**SUCCESSION**









Beam 11 15 3/8

United Rentals  
10508850  
1-800-UR-RENTS

Stack of boxes on a hand truck, likely containing construction materials.

Small wooden structure or cabinet in the middle ground.

Worker on a scissor lift near a large window.















waystar|ROYCO

NEWS

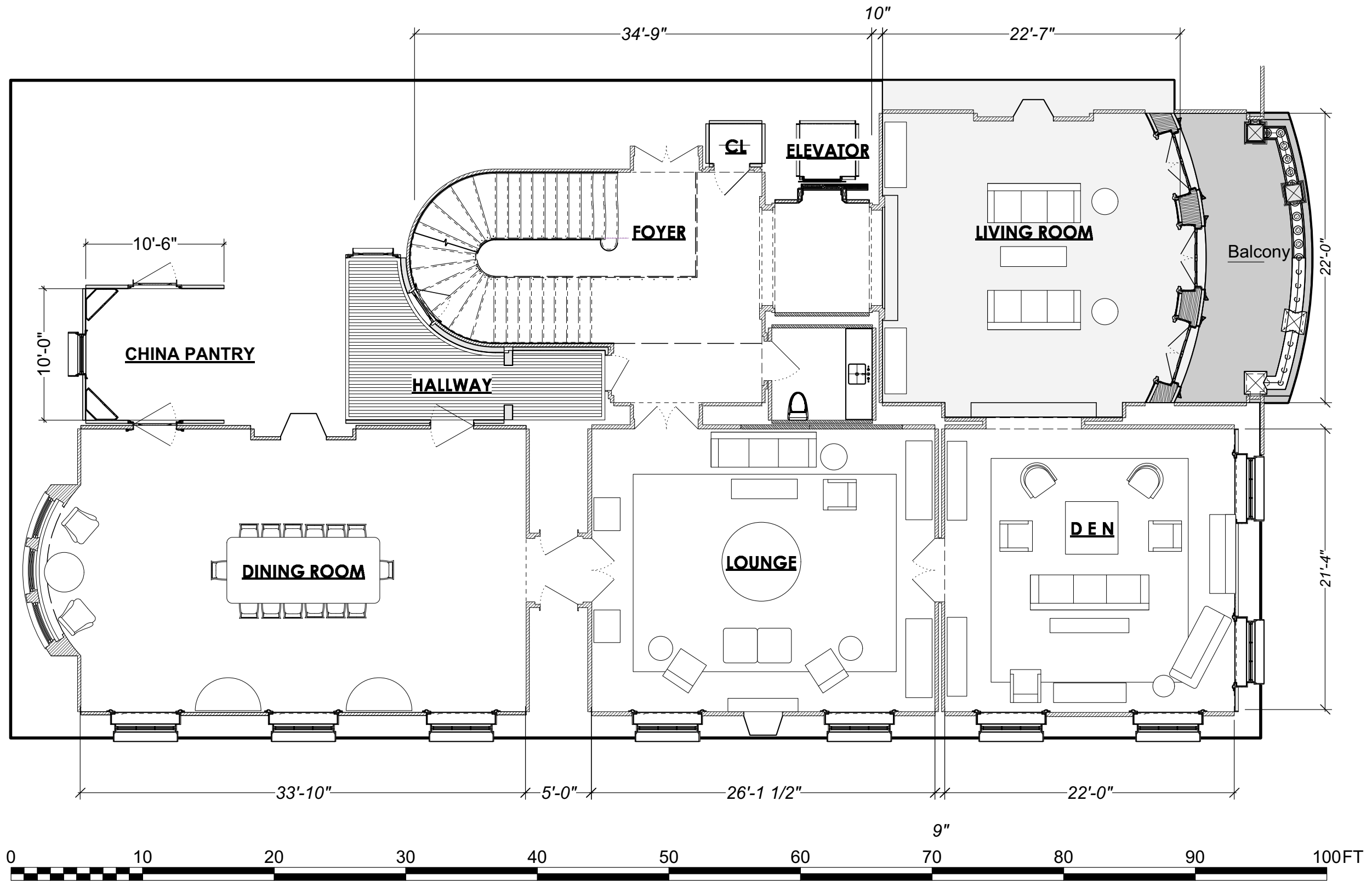

<b>SUCCESSION</b>	Set Name: <b>INT. Logan's Apt.</b>	Set #: <b>201</b>	Released:
	Drawing: <b>DIRECTOR PLAN</b>	Scale: <b>1/8"=1'-0"</b>	Sheet No:
	Location: <b>Silver Cup East Stage "E"</b>	Date: <b>11/03/2017</b>	Drawn By: <b>BKC</b>









































G-DVIP







