

*AARDMAN

Wallace & Gromit
VENGEANCE
MOST FOWL

PRODUCTION DESIGNER - MATT PERRY

EXTERIOR MUSEUM

WALLACE & GROMIT
WORKING FROM HOME LTD

PROJECT NO:	1000 - WALL THEATRE	DATE:	15.11.11	DRAWING TITLE:	EXTERIOR MUSEUM PLAN
DESIGNED BY:	MATT P.	DRAWN BY:	MATT P.	CHECKED BY:	KLJ/JL

AARDMAN

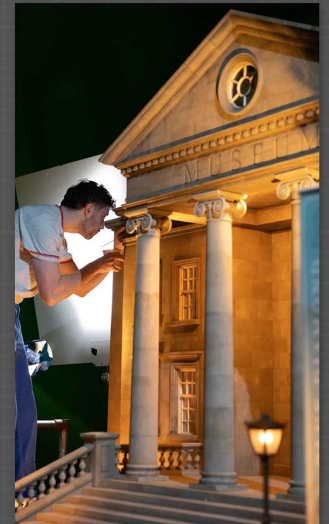
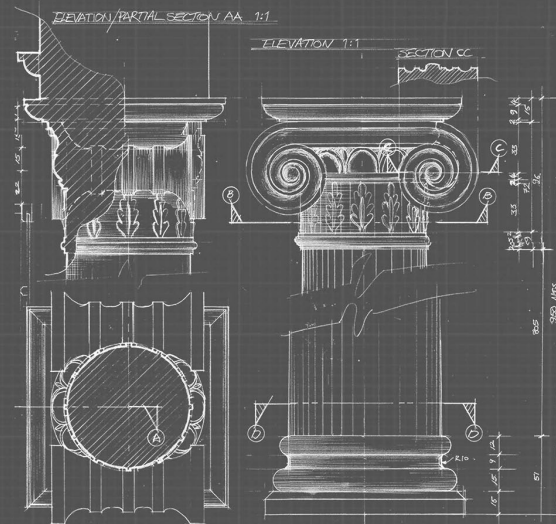
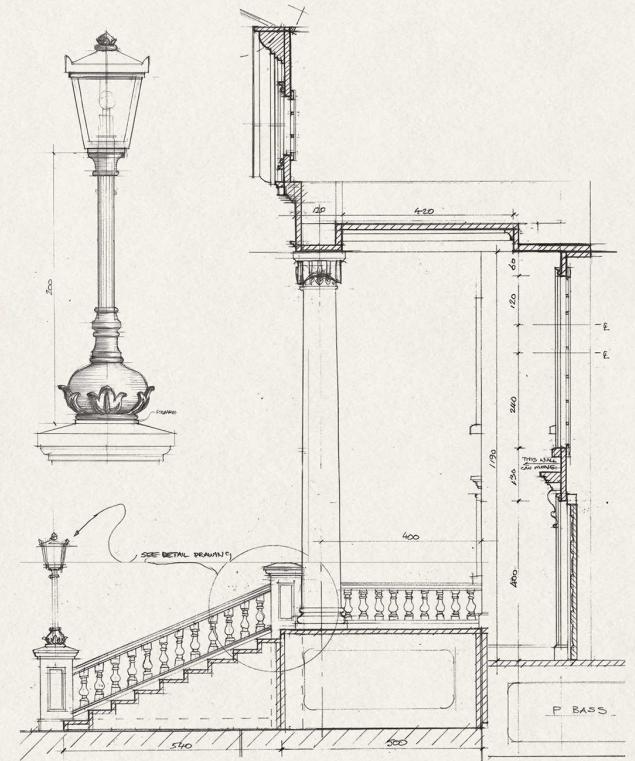

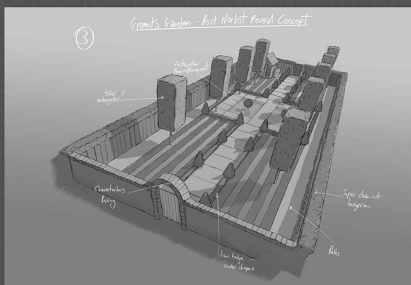
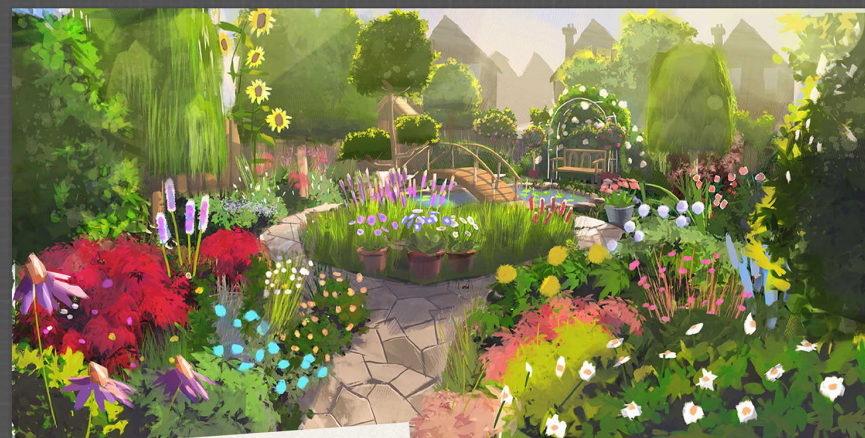



GET-U-UP DELUX

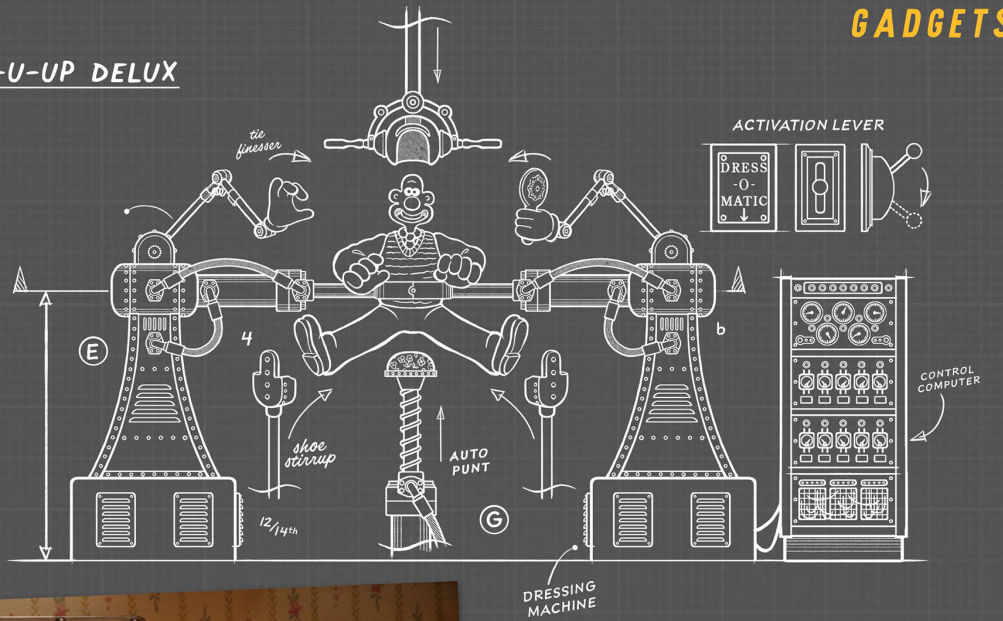

GADGETS

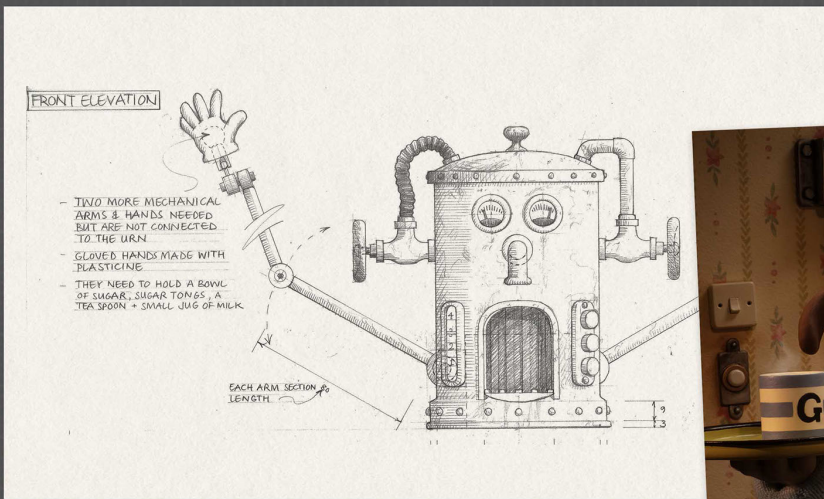

JAM BALLISTA

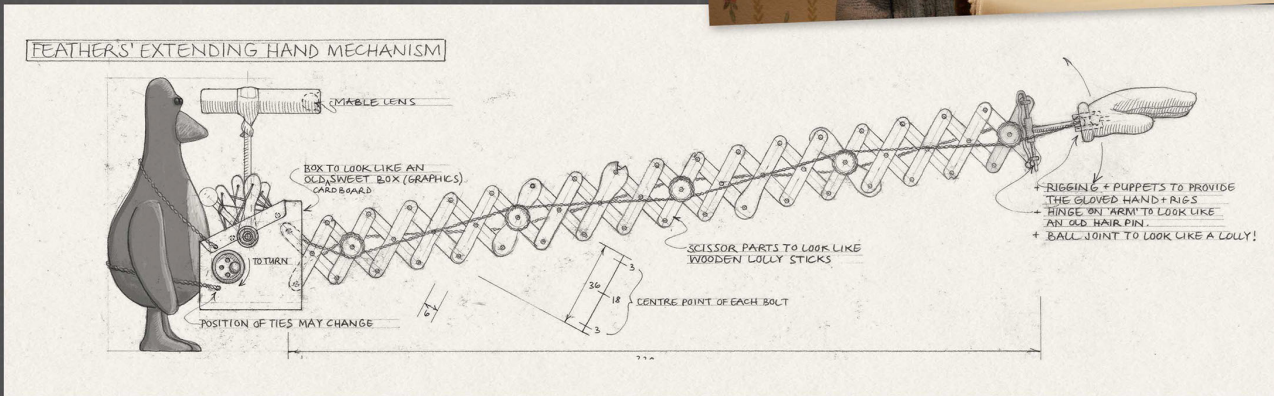

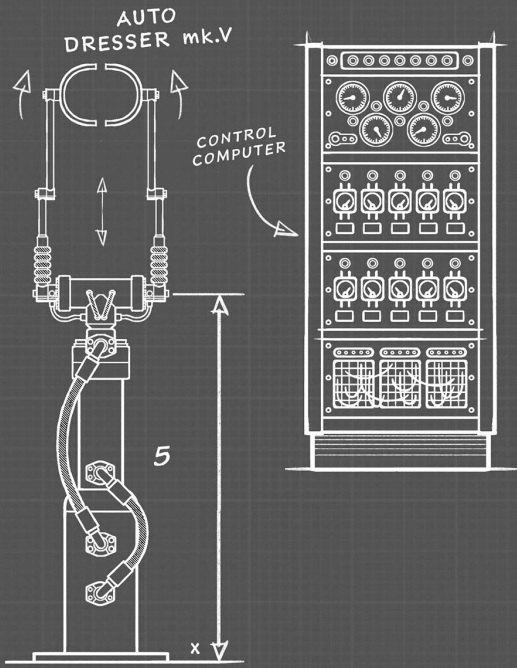

INTERIOR SUBMARINE

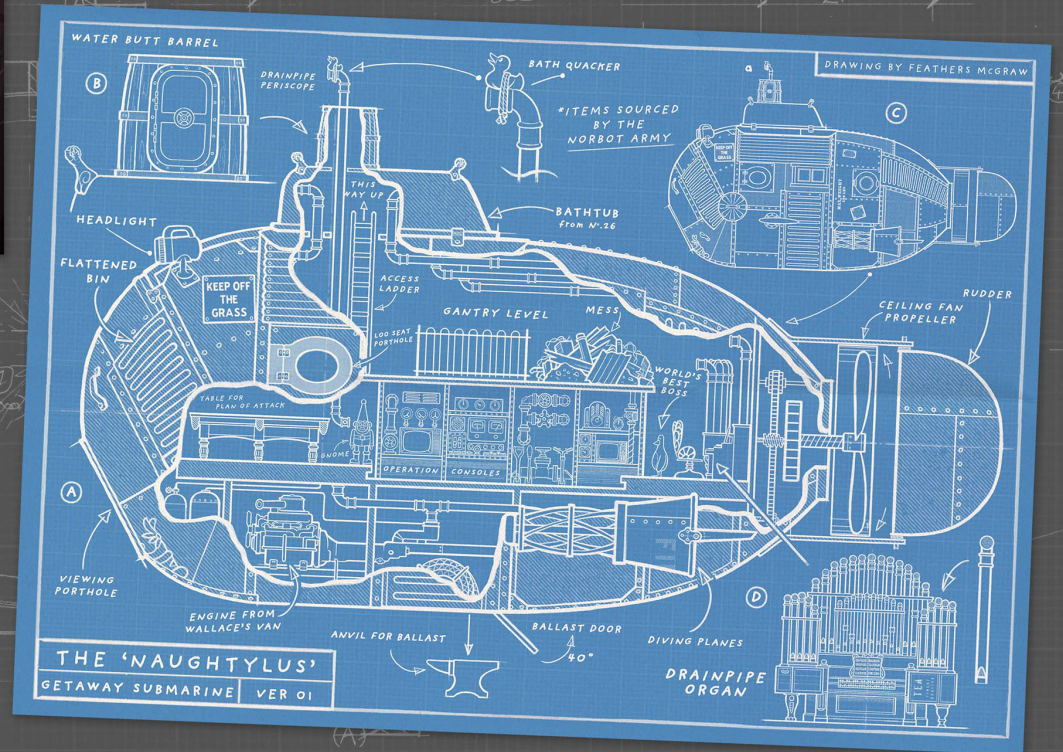
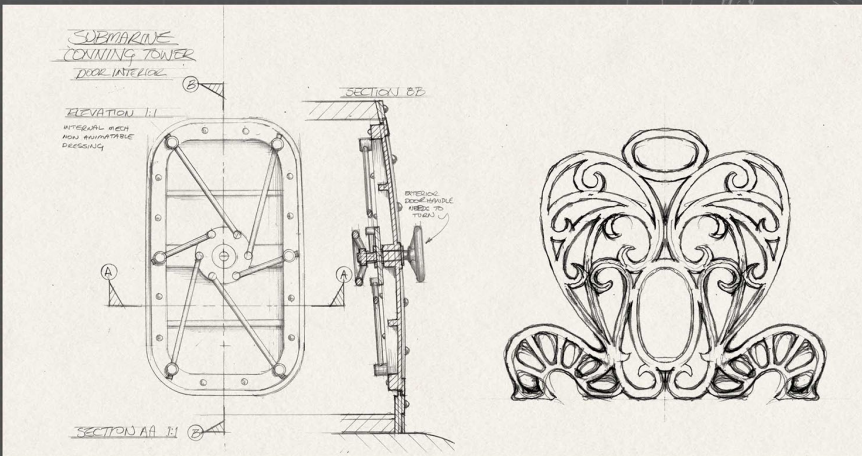
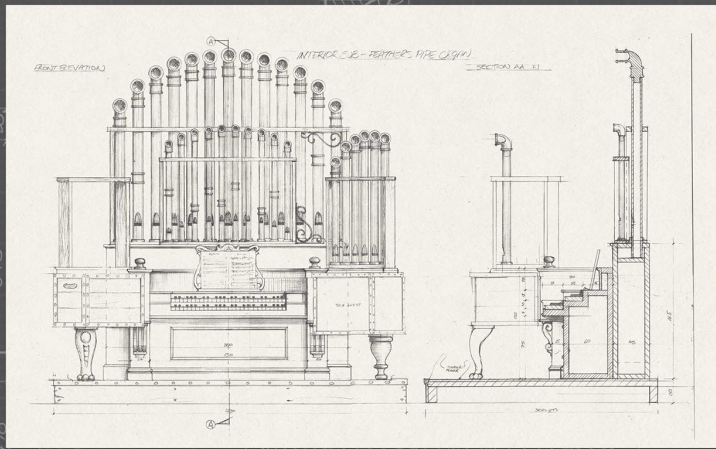

MUSEUM VAULT

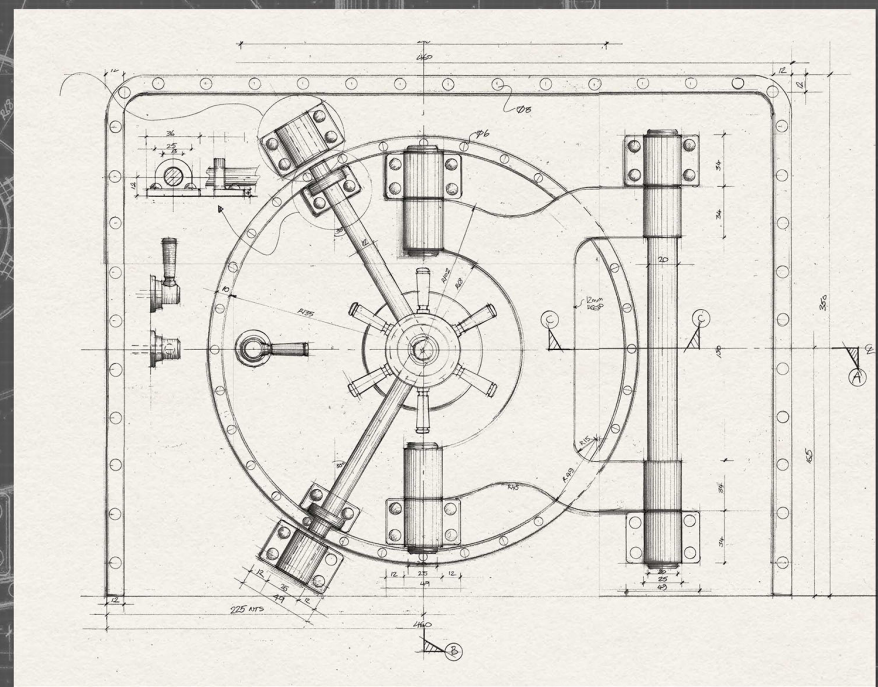
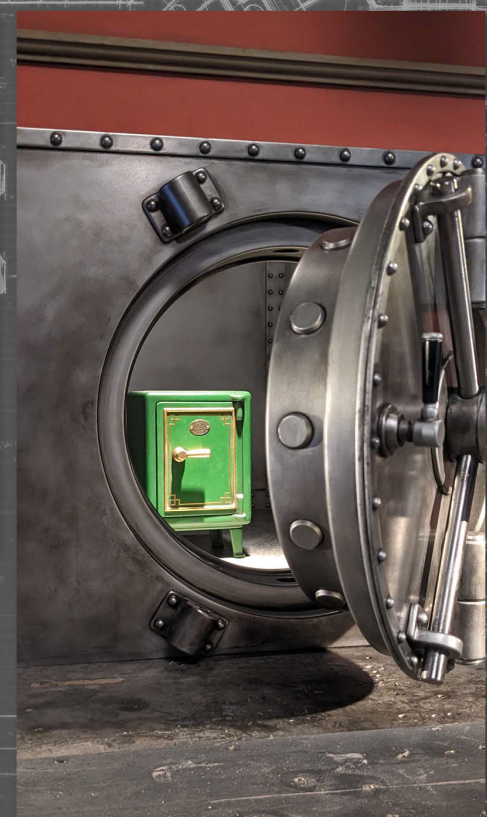
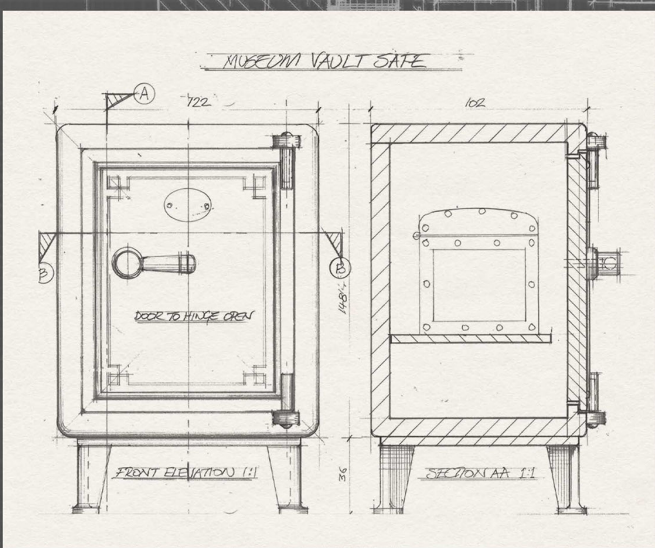
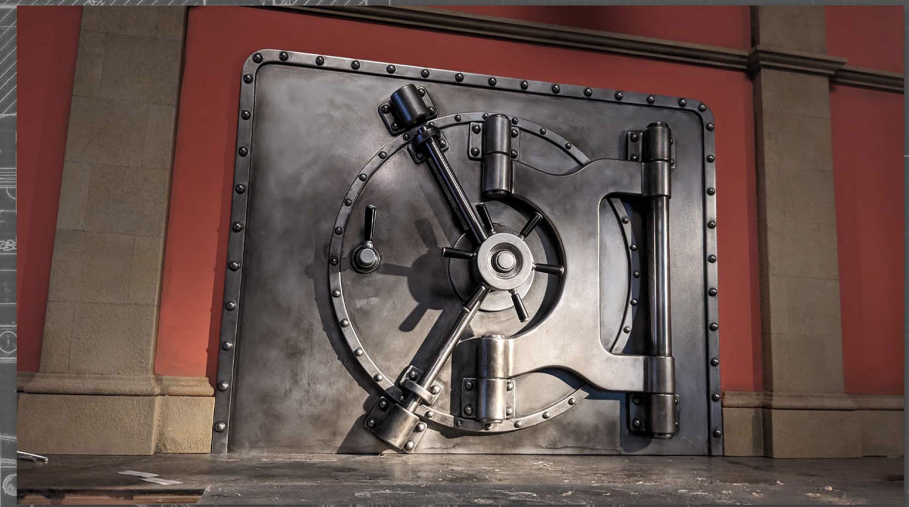

PRISON/ZOO CORRIDOR

ELEVATION AA

ALL PILLARS ARE THE SAME DEPTH

ELEVATION CC

THE ZOO

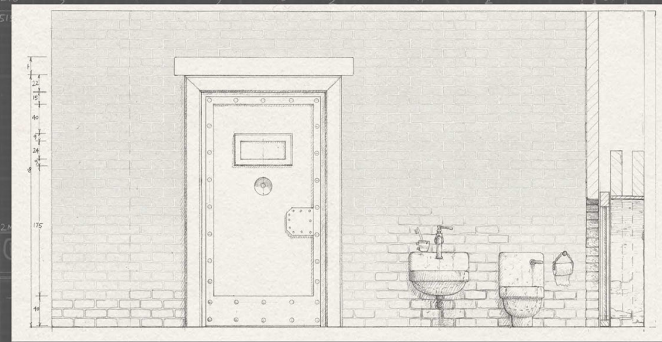
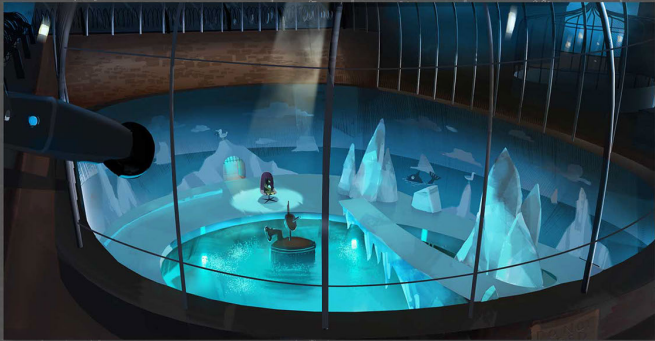
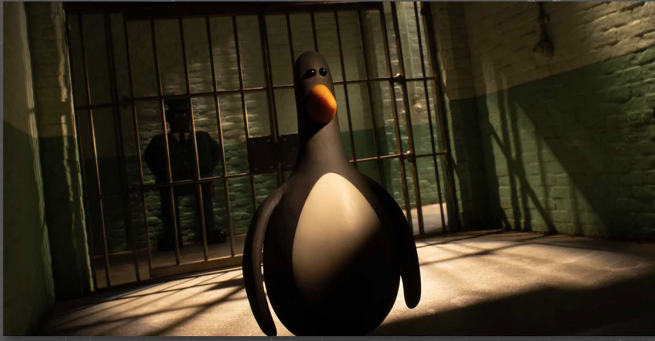

SUBMARINE AND STORM DRAINS

