

29th ADG Awards



**ONE HUNDRED
YEARS OF SOLITUDE**

BEST PRODUCTION DESIGN

*El recuerdo es nítido, pero no hay
ninguna posibilidad de que sea cierto.*

Gabriel García Márquez

**The memory is sharp, but there is no chance of it being true.*

Gabriel García Márquez



**ONE HUNDRED
YEARS OF SOLITUDE**

BUENDÍA HOUSE



ONE HUNDRED
YEARS OF SOLITUDE

TIMELINE
BUENDÍA HOUSE



Temperado 1 - Patio Casa Buendía: J. B. Carstam (1900-1910), G. 6.19

JOSEPH D'AR

ONE HUNDRED
YEARS OF SOLITUDE

CONCEPT ARTWORK
BUENDÍA HOUSE 1 ST STAGE GROWTH



**ONE HUNDRED
YEARS OF SOLITUDE**

CONCEPT ARTWORK
BUENDÍA HOUSE 1 ST STAGE GROWTH



**ONE HUNDRED
YEARS OF SOLITUDE**

**LOCATION INTERIOR/EXTERIOR BUILD
BUENDÍA HOUSE 1 ST STAGE (1858)**



ONE HUNDRED
YEARS OF SOLITUDE

STAGE BUILD
BUENDÍA HOUSE 2ND/3RD STAGE. (1868)



**ONE HUNDRED
YEARS OF SOLITUDE**

STAGE BUILD REVAMP
BUENDÍA HOUSE 4TH STAGE. (1885)



**ONE HUNDRED
YEARS OF SOLITUDE**

BACKLOT MACONDO 2 INTERIOR/EXTERIOR BUILD MATCH
BUENDÍA HOUSE 2ND/3RD STAGE (1868)

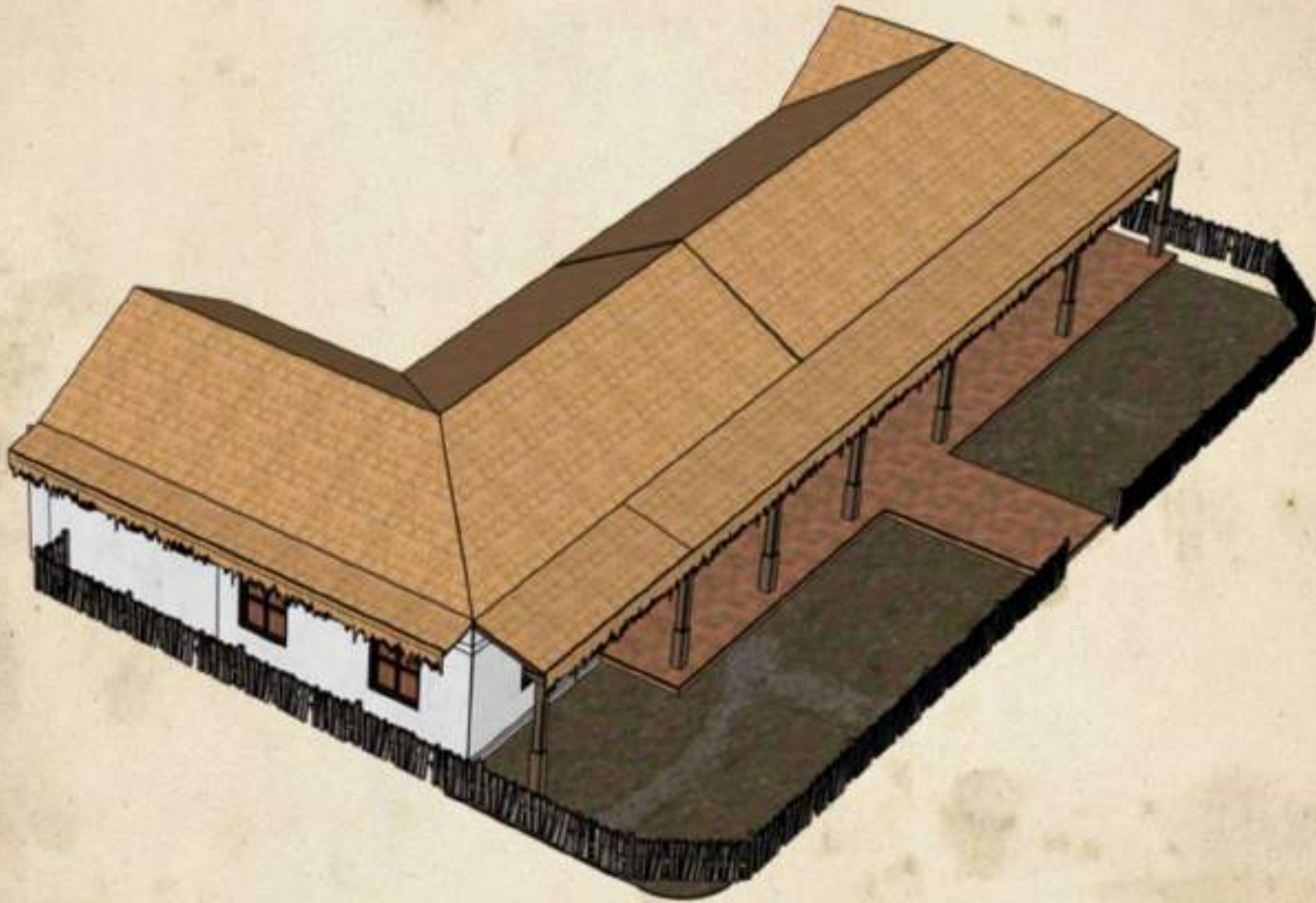

**ONE HUNDRED
YEARS OF SOLITUDE**

BACKLOT MACONDO 4 INTERIOR/EXTERIOR BUILD MATCH
BUENDÍA HOUSE 4TH STAGE (1885)

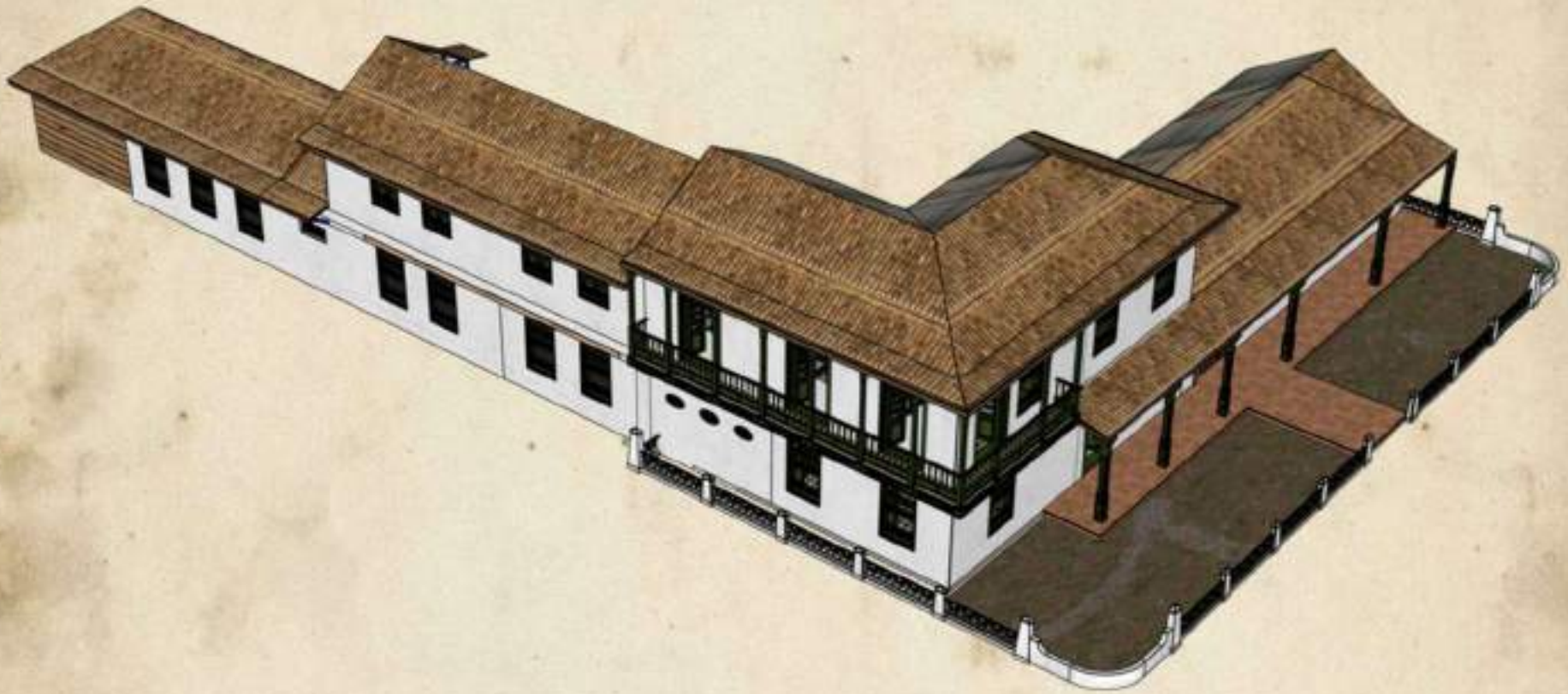

**ONE HUNDRED
YEARS OF SOLITUDE**

STAGE BUILD
BUENDÍA HOUSE 4TH STAGE (1885)



ONE HUNDRED
YEARS OF SOLITUDE

STAGE BUILD
BUENDÍA HOUSE 4TH STAGE (1885)



SOFTDROP BACKING - SLIDING WALLS

**ONE HUNDRED
YEARS OF SOLITUDE**

STAGE BUILD FLOOR PLANS, 2ND FLOOR
BUENDÍA HOUSE 4TH STAGE (1885)



**ONE HUNDRED
YEARS OF SOLITUDE**

STAGE BUILD
BUENDÍA HOUSE 4TH STAGE (1885)



**ONE HUNDRED
YEARS OF SOLITUDE**

STAGE BUILD
BUENDÍA HOUSE 4TH STAGE (1885)

2ND/3RD STAGE (1868)



4TH STAGE (1885)

**ONE HUNDRED
YEARS OF SOLITUDE**

STAGE BUILD
BUENDÍA HOUSE 2ND/3RD STAGE (1868)



2ND/3RD STAGE (1868)

4TH STAGE (1885)

**ONE HUNDRED
YEARS OF SOLITUDE**

STAGE BUILD
BUENDÍA HOUSE 2ND/3RD STAGE (1868)



**ONE HUNDRED
YEARS OF SOLITUDE**

STAGE BUILD
BUENDÍA HOUSE 2ND/3RD STAGE (1868)



**ONE HUNDRED
YEARS OF SOLITUDE**

STAGE BUILD
BUENDÍA HOUSE 2ND/3RD STAGE (1868)

4TH STAGE FLOOR HYDRAULIC TILE INSTALLATION



OVERLAPPED 2ND/3RD STAGE FAUX CLAY TILE FLOORING



OVERLAPPED 2ND/3RD STAGE FAUX CLAY TILE FLOORING

2ND/3RD STAGE REAL CLAY TILE FLOORING

**ONE HUNDRED
YEARS OF SOLITUDE**

**STAGE BUILD REVAMP
BUENDÍA HOUSE 4TH STAGE (1885)**



**ONE HUNDRED
YEARS OF SOLITUDE**

**STAGE BUILD
BUENDÍA HOUSE 4TH STAGE (1885)**



**ONE HUNDRED
YEARS OF SOLITUDE**

STAGE BUILD
BUENDÍA HOUSE 4TH STAGE (1885)



**ONE HUNDRED
YEARS OF SOLITUDE**

DINING HALL
BUENDÍA HOUSE 4TH STAGE (1885)

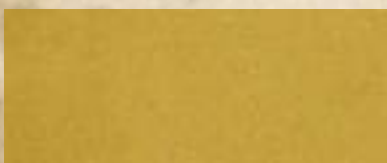
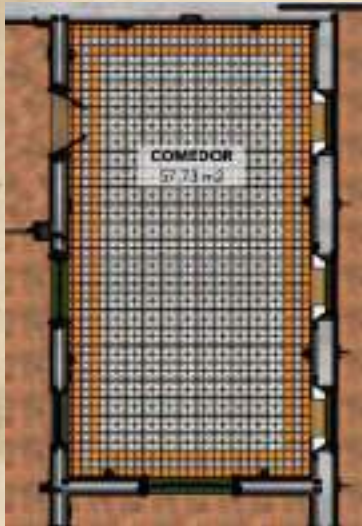

DECORATIVE
PAINTING



**ONE HUNDRED
YEARS OF SOLITUDE**

**DINING HALL
BUENDÍA HOUSE 4TH STAGE (1885)**



ONE HUNDRED YEARS OF SOLITUDE

LIVING ROOM BUENDÍA HOUSE 4TH STAGE (1885)



DECORATIVE PAINTING



**ONE HUNDRED
YEARS OF SOLITUDE**

LIVING ROOM
BUENDÍA HOUSE 4TH STAGE (1885)



**ONE HUNDRED
YEARS OF SOLITUDE**

**LIVING ROOM
BUENDÍA HOUSE 4TH STAGE (1885)**



**ONE HUNDRED
YEARS OF SOLITUDE**

**KNITTING PARLOR
BUENDÍA HOUSE 4TH STAGE (1885)**



DECORATIVE PAINTING



ONE HUNDRED
YEARS OF SOLITUDE

KNITTING PARLOR
BUENDÍA HOUSE 4TH STAGE (1885)



**ONE HUNDRED
YEARS OF SOLITUDE**

**KNITTING PARLOR
BUENDÍA HOUSE 4TH STAGE (1885)**



ONE HUNDRED
YEARS OF SOLITUDE

KITCHEN
BUENDÍA HOUSE 4TH STAGE (1885)



DECORATIVE PAINTING



**ONE HUNDRED
YEARS OF SOLITUDE**

KITCHEN
—•—
BUENDÍA HOUSE 4TH STAGE (1885)



**ONE HUNDRED
YEARS OF SOLITUDE**

CONCEPT ARTWORK
BUENDÍA HOUSE 4TH STAGE (1885)



Casa Buendía, Etapas 2-3. Cocina

**ONE HUNDRED
YEARS OF SOLITUDE**

CONCEPT ARTWORK
BUENDÍA HOUSE 3RD STAGE (1868)



Casa Buendía, Etapa 4. Cocina

ONE HUNDRED
YEARS OF SOLITUDE

KITCHEN
BUENDÍA HOUSE 4TH STAGE (1885)



**ONE HUNDRED
YEARS OF SOLITUDE**

KITCHEN
BUENDÍA HOUSE 4TH STAGE (1885)



**ONE HUNDRED
YEARS OF SOLITUDE**

ÚRSULA AND JOSÉ ARCADIO'S BEDROOM
BUENDÍA HOUSE 4TH STAGE (1885)



**ONE HUNDRED
YEARS OF SOLITUDE**

ÚRSULA AND JOSÉ ARCADIO'S BEDROOM
BUENDÍA HOUSE 4TH STAGE (1885)

CONCEPT ARTWORK



Temperada 1 - Recámara principal Casa Buendía (4ta. etapa - 1885), Gabriel García Márquez

**ONE HUNDRED
YEARS OF SOLITUDE**

ÚRSULA AND JOSÉ ARCADIO'S BEDROOM
BUENDÍA HOUSE 4TH STAGE (1885)



ONE HUNDRED YEARS OF SOLITUDE

JOSÉ ARCADIO JR AND AURELIANO'S BEDROOM BUENDÍA HOUSE 4TH STAGE (1885)



**ONE HUNDRED
YEARS OF SOLITUDE**

**JOSÉ ARCADIO JR AND AURELIANO'S BEDROOM
BUENDÍA HOUSE 4TH STAGE (1885)**



**ONE HUNDRED
YEARS OF SOLITUDE**

AMARANTA'S BEDROOM
BUENDÍA HOUSE 4TH STAGE (1885)



DECORATIVE PAINTING



**ONE HUNDRED
YEARS OF SOLITUDE**

AMARANTA'S BEDROOM
BUENDÍA HOUSE 4TH STAGE (1885)



**ONE HUNDRED
YEARS OF SOLITUDE**

REBECA'S BEDROOM
BUENDÍA HOUSE 4TH STAGE (1885)



DECORATIVE PAINTING



**ONE HUNDRED
YEARS OF SOLITUDE**

REBECA'S BEDROOM
BUENDÍA HOUSE 4TH STAGE (1885)



**ONE HUNDRED
YEARS OF SOLITUDE**

REBECA'S BEDROOM
BUENDÍA HOUSE 4TH STAGE (1885)



ONE HUNDRED YEARS OF SOLITUDE

AURELIANO AND REMEDIO'S ROOM BUENDÍA HOUSE 4TH STAGE (1885)



**ONE HUNDRED
YEARS OF SOLITUDE**

AURELIANO AND REMEDIO'S ROOM
BUENDÍA HOUSE 4TH STAGE (1885)



**ONE HUNDRED
YEARS OF SOLITUDE**

AURELIANO AND REMEDIO'S ROOM
BUENDÍA HOUSE 4TH STAGE (1885)



**ONE HUNDRED
YEARS OF SOLITUDE**

AURELIANO AND REMEDIO'S ROOM
BUENDÍA HOUSE 4TH STAGE (1885)



**ONE HUNDRED
YEARS OF SOLITUDE**

BATHROOM
BUENDÍA HOUSE 4TH STAGE (1885)



**ONE HUNDRED
YEARS OF SOLITUDE**

BATHROOM

BUENDÍA HOUSE 4TH STAGE (1885)



**ONE HUNDRED
YEARS OF SOLITUDE**

AURELIANO'S SILVERSMITH WORKSHOP
BUENDÍA HOUSE 4TH STAGE (1885)

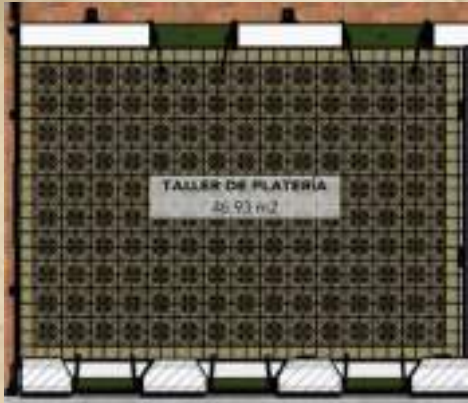

**ONE HUNDRED
YEARS OF SOLITUDE**

AURELIANO'S SILVERSMITH WORKSHOP
BUENDÍA HOUSE 4TH STAGE (1885)



**ONE HUNDRED
YEARS OF SOLITUDE**

AURELIANO'S SILVERSMITH WORKSHOP
BUENDÍA HOUSE 4TH STAGE (1885)



**ONE HUNDRED
YEARS OF SOLITUDE**

AURELIANO'S SILVERSMITH WORKSHOP
BUENDÍA HOUSE 4TH STAGE (1885)
CONCEPT ARTWORK



**ONE HUNDRED
YEARS OF SOLITUDE**

AURELIANO'S SILVERSMITH WORKSHOP
BUENDÍA HOUSE 4TH STAGE (1885)



Pescaditos Aureliano Buendía / Aureliano's little fish

Vista General / General View



Cocula / Scale



Vista Superior / Top View



Vista Inferior / Bottom View



**ONE HUNDRED
YEARS OF SOLITUDE**

**JOSÉ ARCADIO'S ALCHEMY LABORATORY
BUENDÍA HOUSE 4TH STAGE (1885)**



**ONE HUNDRED
YEARS OF SOLITUDE**

JOSÉ ARCADIO'S ALCHEMY LABORATORY
BUENDÍA HOUSE 4TH STAGE (1885)



**ONE HUNDRED
YEARS OF SOLITUDE**

JOSÉ ARCADIO'S ALCHEMY LABORATORY
BUENDÍA HOUSE 4TH STAGE (1885)
CONCEPT ART WORK



**ONE HUNDRED
YEARS OF SOLITUDE**

**JOSÉ ARCADIO'S ALCHEMY LABORATORY
BUENDÍA HOUSE 4TH STAGE (1885)**



**ONE HUNDRED
YEARS OF SOLITUDE**

JOSÉ ARCADIO'S ALCHEMY LABORATORY
BUENDÍA HOUSE 4TH STAGE (1885)



**ONE HUNDRED
YEARS OF SOLITUDE**

MELQUIADES ROOM
BUENDÍA HOUSE 4TH STAGE (1885)



ONE HUNDRED YEARS OF SOLITUDE

MELQUIADES ROOM

BUENDÍA HOUSE 4TH STAGE (1885)



आर्काडियोः अवलोकितवान्
यत् क्षितिजे दीप्तिमाः बुधवारः
उद्भवति
आर्काडियोः अवलोकितवान् यत्
क्षितिजे दीप्तिमाः बुधवारः उद्भवति
गृहविरहार्तिः धूमिका सह अन्तर्धाने
जातः च तस्य स्थाने अपारं
जिह्वासां त्यक्त्वा
वत्सं कदा भित्तिं प्रति पृष्ठं कृत्वा
आज्ञापितः आर्काडियोः आर्द्रकेशीः
पाटलपुष्पयुक्तं वेषं च गृहं
विस्तृतं उद्घाटयन्तं रेवेकाम्
अपरयत्
सः तत् महान्तं प्रबलम् अकरोत्
यत् सः तं ज्ञातुं विजानाति
ननु रेवेकाः अकस्मात् भित्तिं प्रति
अवलोकितवती तथा स्तम्बतायाः
कारणेन मूर्च्छाः अभवत् तथा
च सः आर्काडियं इत्यस्य कृते
हस्तेन विगमं वक्तुं कष्टेन एव
प्रतिक्रियां दातुं शक्नोति स्म
आर्काडियोः तस्मै अपि तथैव
उत्तरं दत्तवान्
तस्मिन् क्षणे आग्नेयनाडीनाम्
धूमकेतुमुल्लरोधनीन् तं निदर्शयन्
च सः मेलकियाडः गीतान्
षक्रपुनस्त्वान् अक्षरसः श्रुतवान्
च तथा कथं

पिएडाचाः कौमारस्य इत्यस्य
अनुभवति स्म च सः नासिकायां तदेव
हिमवतस् कठोरताम्
अनुभवति स्म यत् रेमेडियोस्-शवस्य
नासिकायां तस्य ध्यानं
आकर्षितवान् आसीत्
अहो बत चिन्तयितुं समर्थः अभवत्
अहं विस्मृतवान् यत् यदि स्त्रियाः
जन्म भवति तर्हि
ते तस्याः नाम रेमेदियोः इति
स्थापयन्ति
तथापि व्रणेन नाशकेन सञ्चितः सः
पुनः जीवने यत् आतङ्गं पीडयति स्म
तत् सर्वं अनुभवति स्म
नायकः अपिप्रहारस्य आदेशं दत्तवान्
आर्काडियोः निमेषेण त्यस्य वक्षःस्थलं
बहिः निष्कास्य शिरः उल्थापयितुं
कष्टेन एव समयः सीत् यत् तस्य
ऊरुदग्धः ज्वलनः द्रवः कुतः प्रवहति
इति न अवगच्छति स्म
युयं विजाताः सः क्रन्दितवान्
उदारवर्गः दीर्घकालं जीवतु

**ONE HUNDRED
YEARS OF SOLITUDE**

MELQUIADES ROOM
BUENDÍA HOUSE 4TH STAGE (1885)



ONE HUNDRED YEARS OF SOLITUDE

MELQUIADES' BOOK BUENDÍA HOUSE 4TH STAGE (1885)



ACABADO REPUJADO
SOBRE FALSO NERVIO

36 cm

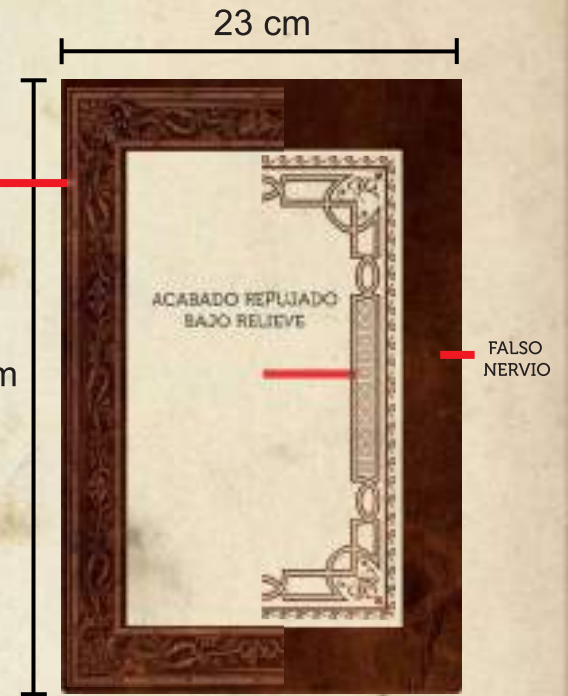

10 cm



10 cm



ONE HUNDRED YEARS OF SOLITUDE

MELQUIADES' BOOK

BUENDÍA HOUSE 4TH STAGE (1885)



बहवर्षेभ्यः अन्तरम् गोलीकाण्डतस्य सम्मूलीभूय
 सूर्यमख्यः ओरिलियानी वपन्ना तुम् वृक्षं अपराह
 सैरति स्म पडा तस्य पिता तम् हिमदेशीनाथं नीतवान् ।
 मकोण्डो विशति
 नलीतमस्य च
 तुरणातस्य
 गहनास्य ग्रामः आसीत्,
 स्वच्छजलस्य नदीतटे
 निर्मितः आसीत्, य
 पालिशतशिलाव्यायाः
 अधः द्रुत गच्छन्ति स्म
 कृताः प्राचीनाण्डवत्
 विशालाः च आसन् ।



जगत् एतावत् अद्यतमम् आसीत्, अनेकेषां
 वस्तूनाम् नाशान्ना अभावः आसीत् तेषां उल्लेखाध
 अद्गुली दर्शयितव्या आसीत् ।



**ONE HUNDRED
YEARS OF SOLITUDE**

BARN

BUENDÍA HOUSE 4TH STAGE (1885)



ONE HUNDRED
YEARS OF SOLITUDE

BARN

BUENDÍA HOUSE 4TH STAGE (1885)



ONE HUNDRED
YEARS OF SOLITUDE

BARN

BUENDÍA HOUSE 4TH STAGE (1885)



**ONE HUNDRED
YEARS OF SOLITUDE**

THE COURTYARDS
BUENDÍA HOUSE 4TH STAGE (1885)

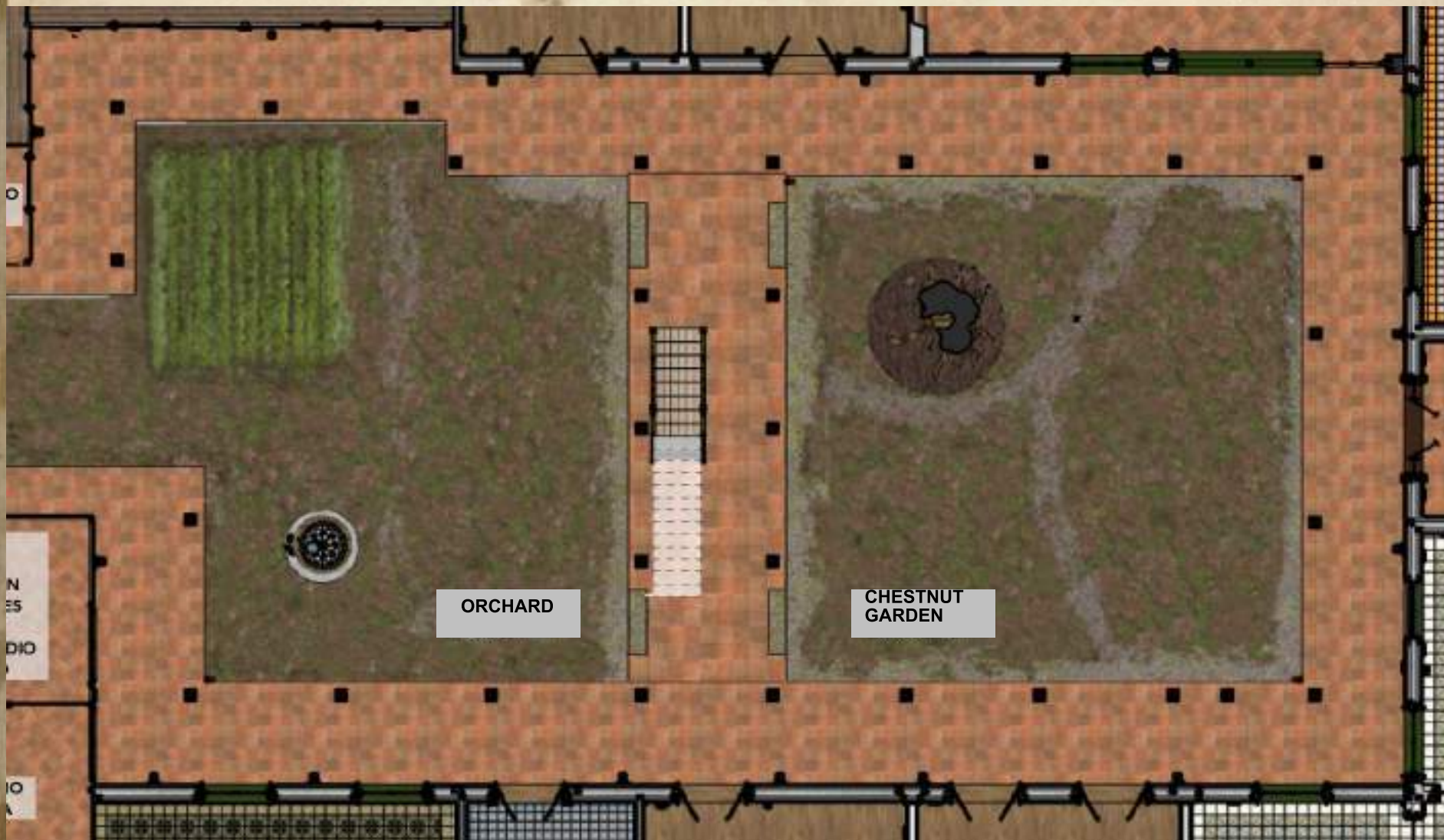

**ONE HUNDRED
YEARS OF SOLITUDE**

THE COURTYARDS
BUENDÍA HOUSE 4TH STAGE (1885)



**ONE HUNDRED
YEARS OF SOLITUDE**

THE COURTYARDS
BUENDÍA HOUSE 4TH STAGE (1885)



**ONE HUNDRED
YEARS OF SOLITUDE**

THE COURTYARDS
BUENDÍA HOUSE 4TH STAGE (1885)



**ONE HUNDRED
YEARS OF SOLITUDE**

THE COURTYARDS
BUENDÍA HOUSE 4TH STAGE (1885)



**ONE HUNDRED
YEARS OF SOLITUDE**

THE COURTYARDS
BUENDÍA HOUSE 4TH STAGE (1885)



**ONE HUNDRED
YEARS OF SOLITUDE**

THE COURTYARDS
BUENDÍA HOUSE 4TH STAGE (1885)



**ONE HUNDRED
YEARS OF SOLITUDE**

THE COURTYARDS
BUENDÍA HOUSE 4TH STAGE (1885)



**ONE HUNDRED
YEARS OF SOLITUDE**

THE COURTYARDS
BUENDÍA HOUSE 4TH STAGE (1885)



**ONE HUNDRED
YEARS OF SOLITUDE**

MACONDO 4 BACKLOT BUILD
BUENDÍA HOUSE 4TH STAGE (1885)



ONE HUNDRED
YEARS OF SOLITUDE

CONCEPT ARTWORK

BUENDÍA HOUSE 4TH STAGE (1885)



Temporada 4 - Inhabita casa Buendía (último golpe a muro (barrido plano)), Semana 4/1885

**ONE HUNDRED
YEARS OF SOLITUDE**

MACONDO 4 BACKLOT BUILD
BUENDÍA HOUSE 4TH STAGE



BUENDÍA HOUSE 4TH STAGE





ONE HUNDRED
YEARS OF SOLITUDE

MACONDO 4 BACKLOT BUILD / ELEVATIONS

BUENDÍA HOUSE 4TH STAGE



**ONE HUNDRED
YEARS OF SOLITUDE**

MACONDO 4 BACKLOT BUILD
BUENDÍA HOUSE 4TH STAGE (1885)



**ONE HUNDRED
YEARS OF SOLITUDE**

MACONDO 4 BACKLOT BUILD
BUENDÍA HOUSE 4TH STAGE (1885)



**ONE HUNDRED
YEARS OF SOLITUDE**

MACONDO 4 BACKLOT BUILD
BUENDÍA HOUSE 4TH STAGE (1885)



**ONE HUNDRED
YEARS OF SOLITUDE**

MACONDO 4 BACKLOT BUILD
BUENDÍA HOUSE 4TH STAGE (1885)



**ONE HUNDRED
YEARS OF SOLITUDE**

MACONDO 4 BACKLOT BUILD
BUENDÍA HOUSE 4TH STAGE (1885)



**ONE HUNDRED
YEARS OF SOLITUDE**

MACONDO 4 BACKLOT BUILD
BUENDÍA HOUSE 4TH STAGE (1885)



**ONE HUNDRED
YEARS OF SOLITUDE**

MACONDO 4 BACKLOT BUILD
BUENDÍA HOUSE 4TH STAGE (1885)



**ONE HUNDRED
YEARS OF SOLITUDE**

MACONDO 4

BUENDÍA HOUSE 4TH STAGE (1885)



**ONE HUNDRED
YEARS OF SOLITUDE**

MACONDO 4

BUENDÍA HOUSE'S CHESTNUT TREE



**ONE HUNDRED
YEARS OF SOLITUDE**

THE CHESTNUT TREE / FIRST CLAY MODEL
BUENDÍA HOUSE'S CHESTNUT TREE



**ONE HUNDRED
YEARS OF SOLITUDE**

SCULPTURE PROCESS
BUENDÍA HOUSE'S CHESTNUT TREE



**ONE HUNDRED
YEARS OF SOLITUDE**

SCULPTURE PROCESS
BUENDÍA HOUSE'S CHESTNUT TREE



**ONE HUNDRED
YEARS OF SOLITUDE**

SCULPTURE PROCESS
BUENDÍA HOUSE'S CHESTNUT TREE



**ONE HUNDRED
YEARS OF SOLITUDE**

SCULPTURE PROCESS
BUENDÍA HOUSE'S CHESTNUT TREE



**ONE HUNDRED
YEARS OF SOLITUDE**

SCULPTURE PROCESS
BUENDÍA HOUSE'S CHESTNUT TREE



ONE HUNDRED
YEARS OF SOLITUDE

SCULPTURE PROCESS
BUENDÍA HOUSE'S CHESTNUT TREE



ONE HUNDRED
YEARS OF SOLITUDE

VFX ENHANCEMENT PROCESS
BUENDÍA HOUSE 4TH STAGE

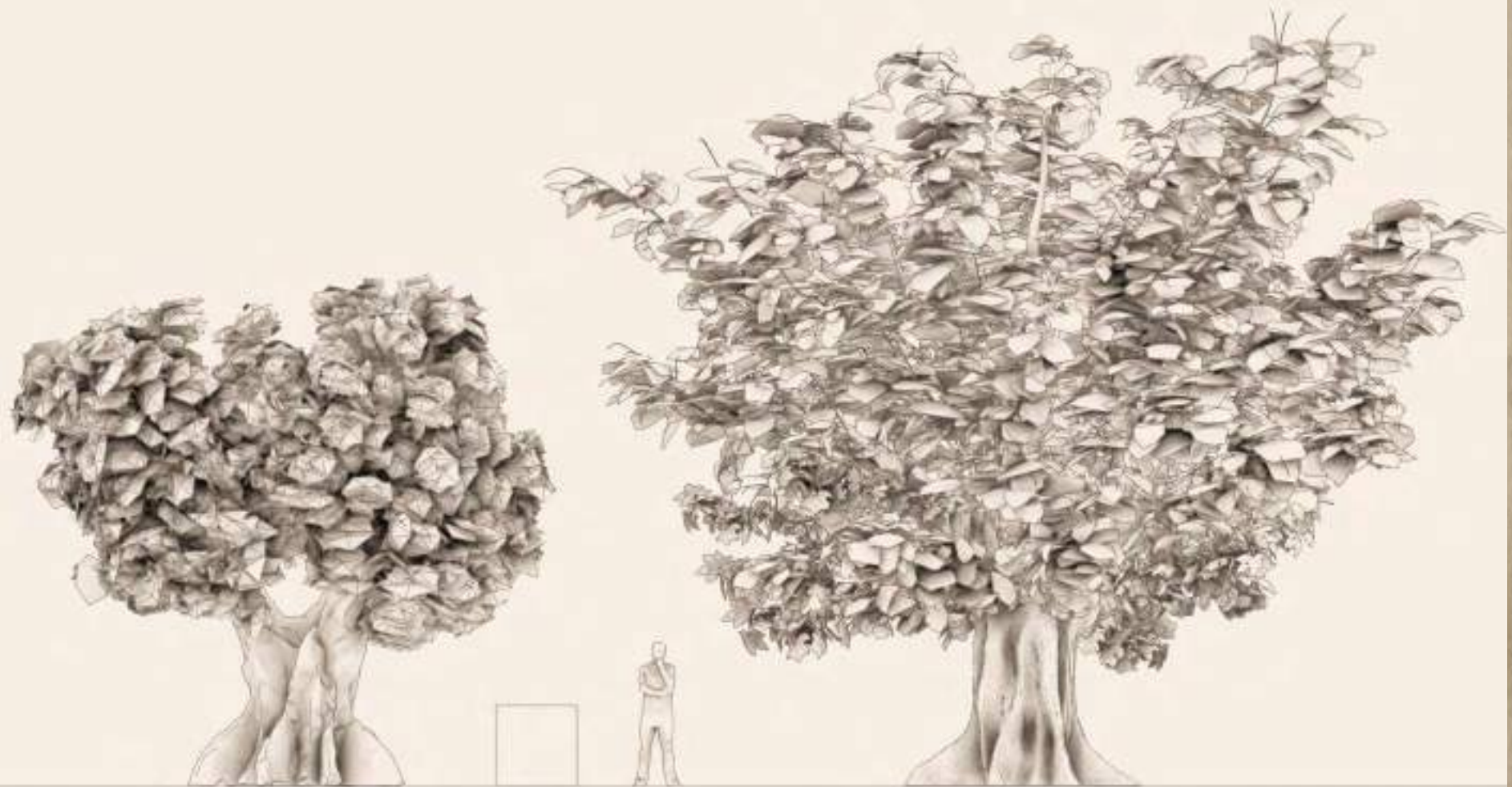

SCANNED SCULPTURE

LEAF ENHANCEMENT

**ONE HUNDRED
YEARS OF SOLITUDE**

FINAL VFX ENHANCEMENT
BUENDÍA HOUSE 4TH STAGE



**ONE HUNDRED
YEARS OF SOLITUDE**

THE CHESTNUT TREE
BUENDÍA HOUSE 4TH STAGE



**ONE HUNDRED
YEARS OF SOLITUDE**

THE CHESTNUT TREE
BUENDÍA HOUSE 4TH STAGE



**ONE HUNDRED
YEARS OF SOLITUDE**

REMEDIOS & AURELIANO'S WEDDING
BUENDÍA HOUSE 4TH STAGE
CONCEPT ARTWORK



**ONE HUNDRED
YEARS OF SOLITUDE**

REMEDIOS & AURELIANO'S WEDDING
BUENDÍA HOUSE 4TH STAGE



**ONE HUNDRED
YEARS OF SOLITUDE**

REMEDIOS & AURELIANO'S WEDDING
BUENDÍA HOUSE 4TH STAGE



**ONE HUNDRED
YEARS OF SOLITUDE**

REMEDIOS & AURELIANO'S WEDDING
BUENDÍA HOUSE 4TH STAGE



**ONE HUNDRED
YEARS OF SOLITUDE**

REMEDIOS & AURELIANO'S WEDDING
BUENDÍA HOUSE 4TH STAGE
SET DECORATION



**ONE HUNDRED
YEARS OF SOLITUDE**

REMEDIOS & AURELIANO'S WEDDING
BUENDÍA HOUSE 4TH STAGE
SET DECORATION





**ONE HUNDRED
YEARS OF SOLITUDE**

MACONDO 4



ONE HUNDRED
YEARS OF SOLITUDE

CONCEPT ARTWORK
MACONDO



Temperado / Macondo, Estadio

STAGE 1

**ONE HUNDRED
YEARS OF SOLITUDE**

**CONCEPT ARTWORK
MACONDO**



STAGE 1



STAGE 1



STAGE 4

ONE HUNDRED
YEARS OF SOLITUDE

STILS
MACONDO



STIL



STIL



STIL

ONE HUNDRED
YEARS OF SOLITUDE

STILS
MACONDO



ONE HUNDRED YEARS OF SOLITUDE

LOCATION BUILD MACONDO - STAGE 1



RENDER

BUILDING PROCESS



RENDERS

ONE HUNDRED
YEARS OF SOLITUDE

CONCEPT ARTWORK
MACONDO 2/3



Temperada / Macondo, Etapas 2 y 3

STAGE 2/3

ONE HUNDRED
YEARS OF SOLITUDE

BACKLOT BUILD
MACONDO - STAGE 2/3



STILL



CONCEPT



SET BUILD

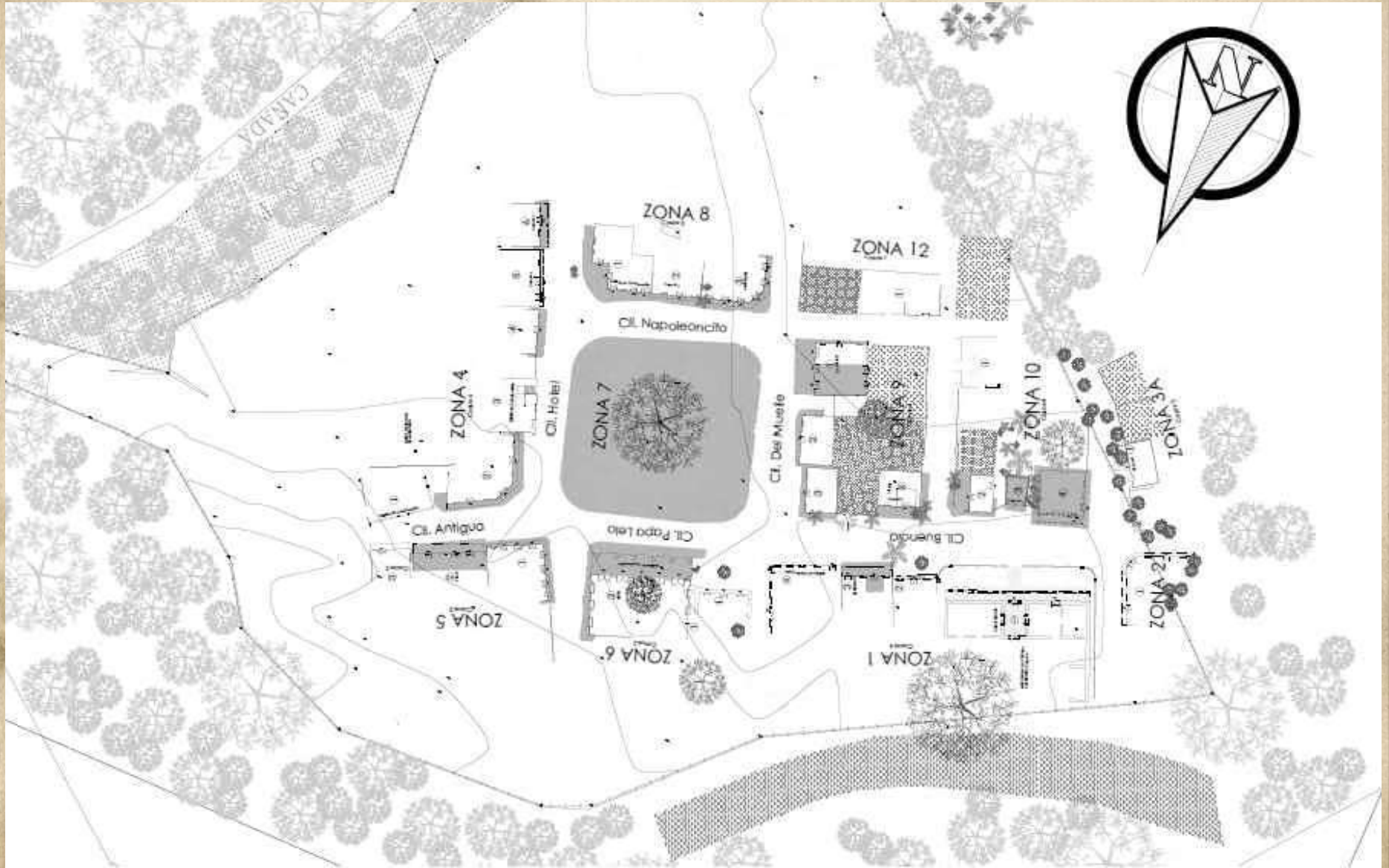

ONE HUNDRED
YEARS OF SOLITUDE

BACKLOT BUILD
BACKLOT STAGE 2/3 - AERIAL VIEW



ONE HUNDRED
YEARS OF SOLITUDE

BACKLOT BUILD
BACKLOT STAGE 2/3 - RENDERS

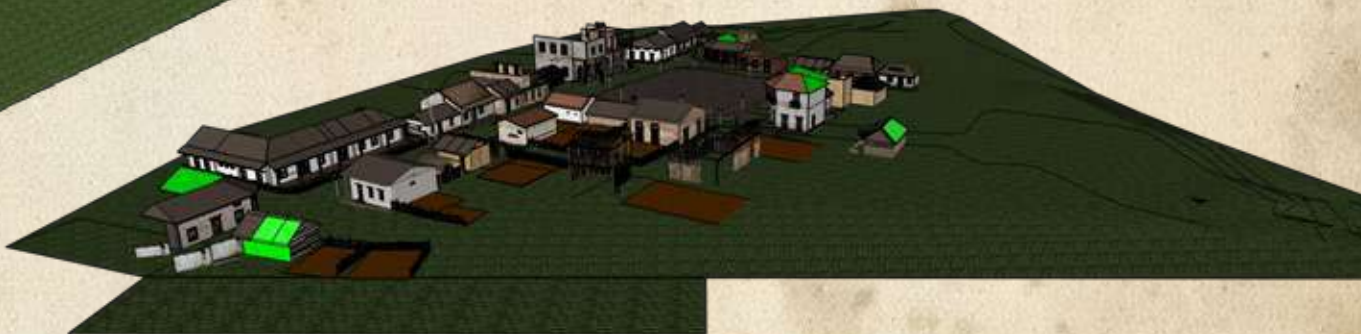

ONE HUNDRED YEARS OF SOLITUDE

BACKLOT BUILD MACONDO STAGE 2/3 - FACADE PLANS & RENDERS



4 ADARRÓTES
FACHADA FRONTAL



3 ADARRÓTES
FACHADA LATERAL



ONE HUNDRED YEARS OF SOLITUDE

BACKLOT BUILD MACONDO STAGE 2/3 - FACADE PLANS & RENDERS

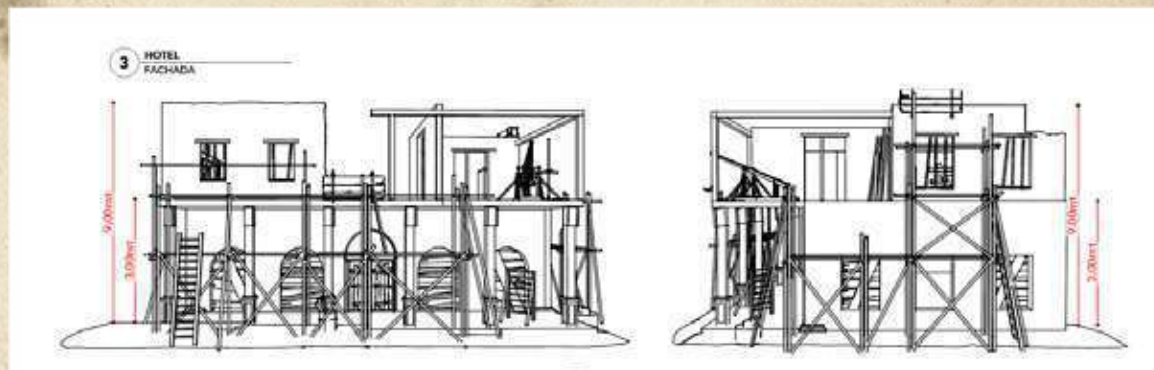

ONE HUNDRED
YEARS OF SOLITUDE

BACKLOT BUILD
MACONDO - STAGE 2/3 - FINISHED SETS



ONE HUNDRED
YEARS OF SOLITUDE

BACKLOT BUILD
MACONDO - STAGE 2/3 - FINISHED SETS



STIL

ONE HUNDRED
YEARS OF SOLITUDE

STILS
MACONDO - STAGE 2/3



STIL



STIL



STIL

ONE HUNDRED
YEARS OF SOLITUDE

STILS
MACONDO - STAGE 2/3



ONE HUNDRED
YEARS OF SOLITUDE

CONCEPT ARTWORK
MACONDO 4



Temporada 1 / Macondo, Etapa 4

STAGE 4

ONE HUNDRED
YEARS OF SOLITUDE

BACKLOT BUILD
MACONDO - STAGE 4



CONCEPT



STILL



SET BUILD

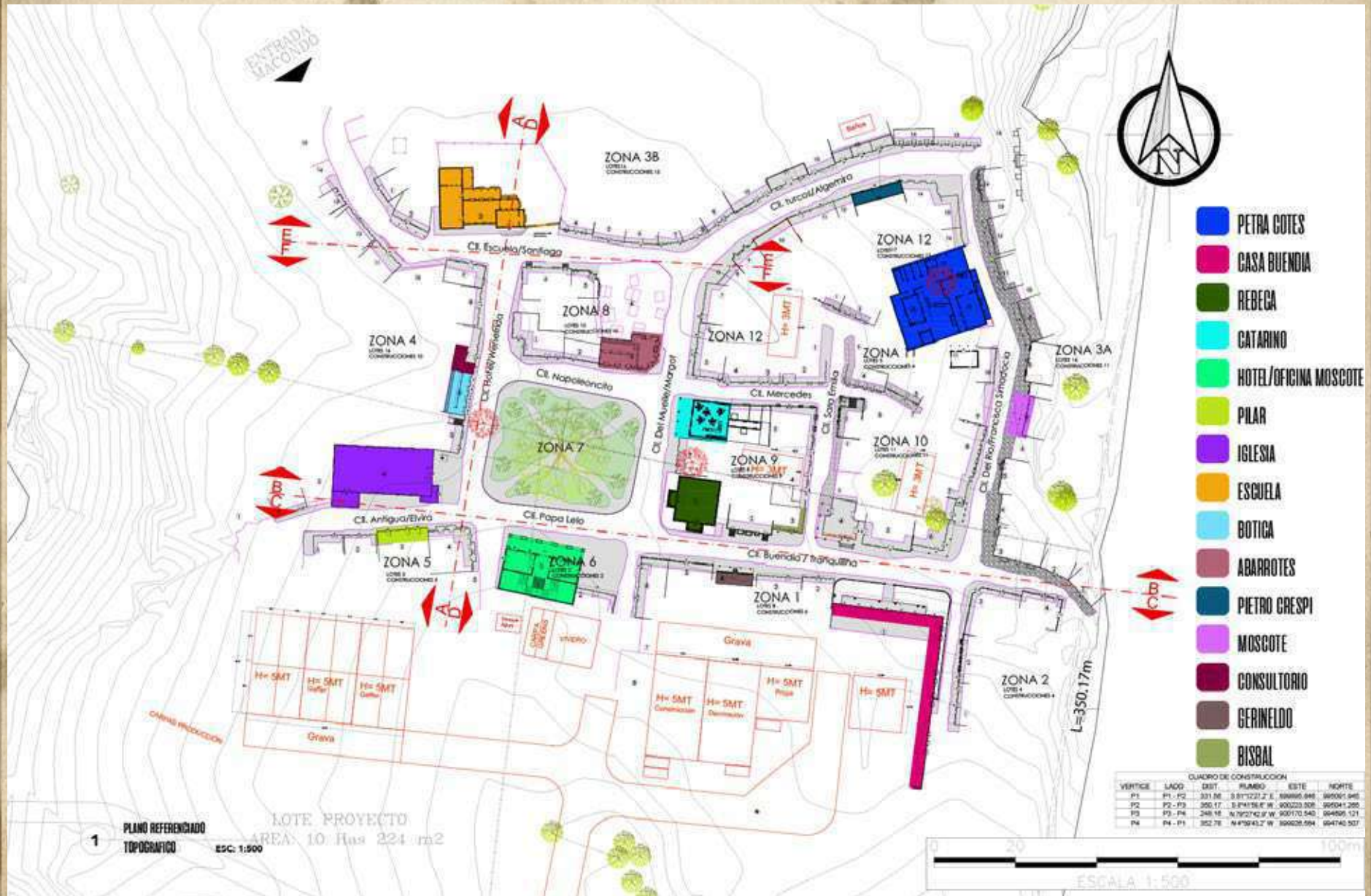

**ONE HUNDRED
YEARS OF SOLITUDE**

BACKLOT BUILD
BACKLOT STAGE 4 - AERIAL VIEW



ONE HUNDRED YEARS OF SOLITUDE

BACKLOT BUILD BACKLOT STAGE 4 - RENDERS

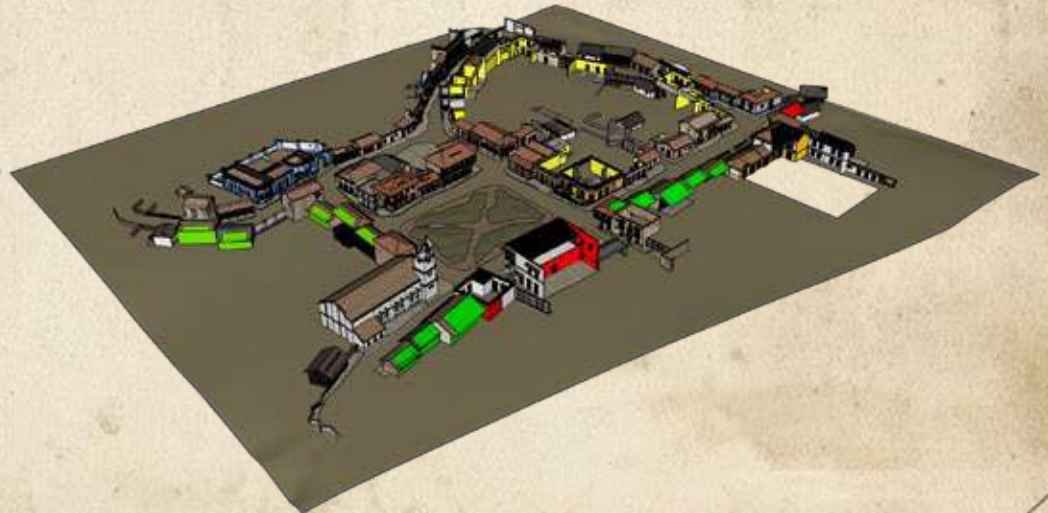
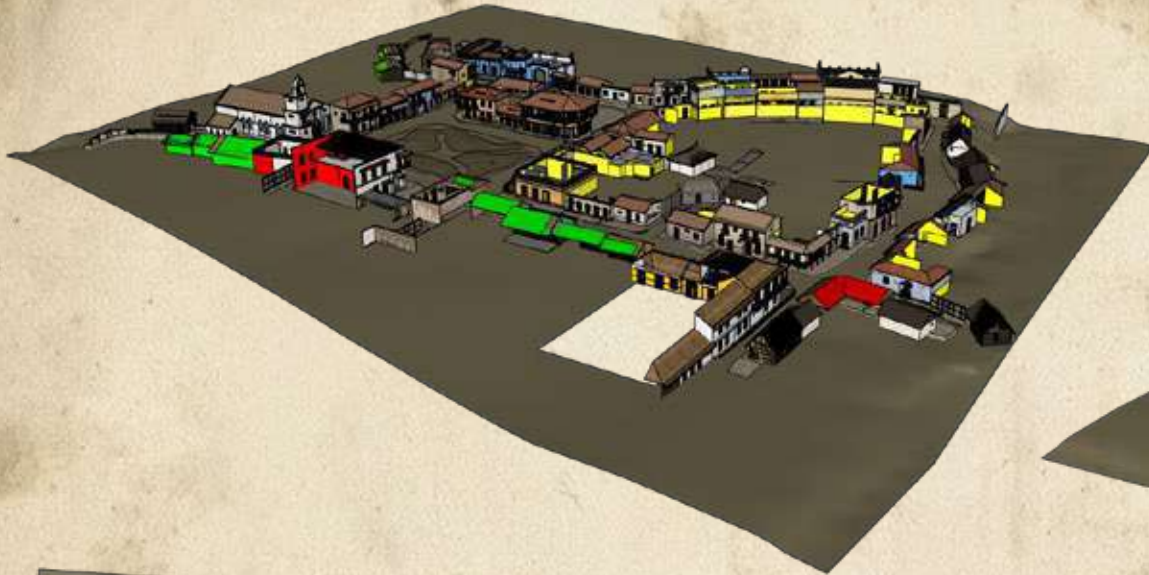

ONE HUNDRED YEARS OF SOLITUDE

BACKLOT BUILD BACKLOT STAGE 4 - RENDERS



ONE HUNDRED
YEARS OF SOLITUDE

BACKLOT BUILD
MACONDO STAGE 4 - RENDERS



ONE HUNDRED YEARS OF SOLITUDE

BACKLOT BUILD MACONDO STAGE 4 - RENDERS



ONE HUNDRED
YEARS OF SOLITUDE

BACKLOT BUILD
MACONDO - STAGE 4 - FINISHED SETS



**ONE HUNDRED
YEARS OF SOLITUDE**

BACKLOT BUILD
MACONDO - STAGE 4 - FINISHED SETS



**ONE HUNDRED
YEARS OF SOLITUDE**

**BACKLOT BUILD
MACONDO - STAGE 4 - FINISHED SETS**



ONE HUNDRED
YEARS OF SOLITUDE

GRAPHICS
MACONDO - STAGE 4

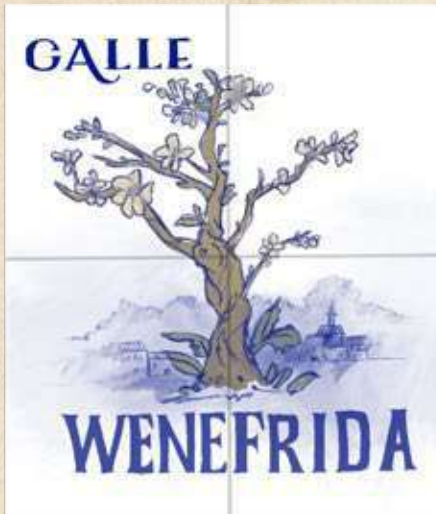
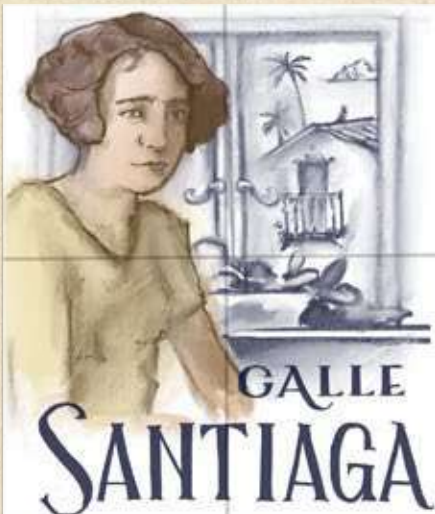
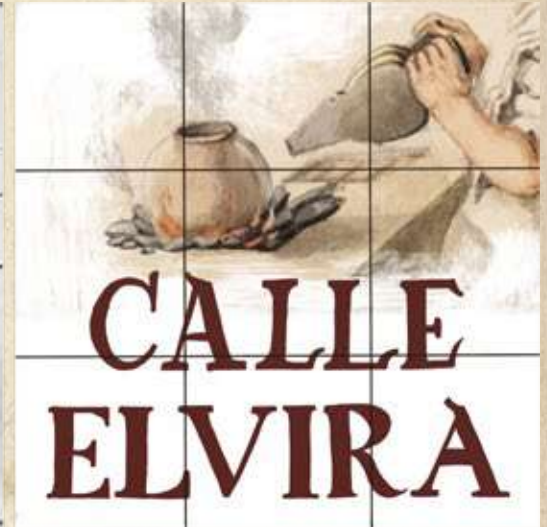

ONE HUNDRED
YEARS OF SOLITUDE

GRAPHICS
MACONDO - STAGE 4

HOTEL JACOB

Plateria Lazzcano

FRAGUA

GARZON HERMANOS
FRAGUA

HOTEL
JACOB

CALLE
DE
ALGEMIRA

ONE HUNDRED
YEARS OF SOLITUDE

STILLS
MACONDO - STAGE 4



**ONE HUNDRED
YEARS OF SOLITUDE**

STILLS
— — — — —
MACONDO - STAGE 4



**ONE HUNDRED
YEARS OF SOLITUDE**

STILLS
MACONDO - STAGE 4





**ONE HUNDRED
YEARS OF SOLITUDE**

MOSCOTE HOUSE



**ONE HUNDRED
YEARS OF SOLITUDE**

MOSCOTE HOUSE
—+—
MACONDO 4 - BACKLOT FACADE BUILD
LOCATION MATCHING



1 MACONDO 4 - CASA MOSCOTE CASA-LOCACIÓN

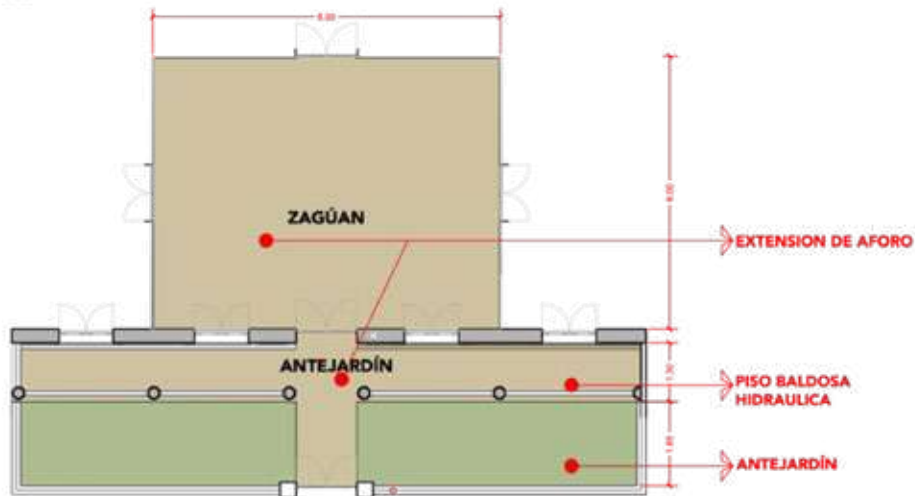

PISO ANTEJARDÍN



PISO ZAGÚAN



2 MACONDO 4 - CASA MOSCOTE CASA-LOTE MACONDO 4

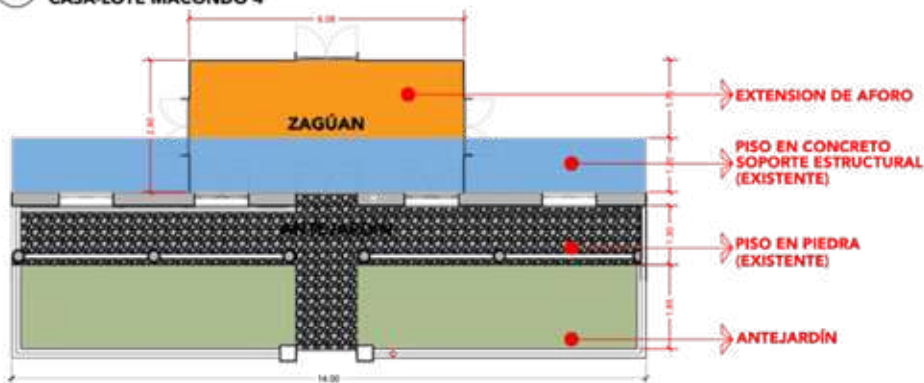

**ONE HUNDRED
YEARS OF SOLITUDE**

MOSCOTE HOUSE
—+—
MACONDO 4 - BACKLOT FACADE BUILD
LOCATION MATCHING



**ONE HUNDRED
YEARS OF SOLITUDE**

MOSCOTE HOUSE
LOCATION PARTIAL BUILD & DRESSING



ONE HUNDRED YEARS OF SOLITUDE

MOSCOTE HOUSE LOCATION PARTIAL BUILD & DRESSING

COLOR

La carpintería se pintará de azul y las paredes de un blanco cálido

Se utilizarán pinturas barnizadas para la Carpintería y vinilo de buena calidad para las paredes.



VENTANAS EXTERIORES

Las ventanas con vista al exterior se cambiarán por persianas típicas de las casas del Caribe de esa época. Dejan entrar la luz pero evitan que veamos hacia el exterior.
Se reemplazarán las ventanas existentes pero al momento de la entrega se volverán a poner las ventanas propias de la casa.
Se retiran las rejas que encontramos en las ventanas que dan al frente de la casa y se volverán a poner y a pintar en el momento de la entrega.



PUERTAS CON VIDRIOS

Se cambiarán las puertas que tienen vidrios por puertas de madera iguales a las que encontramos en la casa



ONE HUNDRED YEARS OF SOLITUDE

MOSCOTE HOUSE LOCATION PARTIAL BUILD & DRESSING

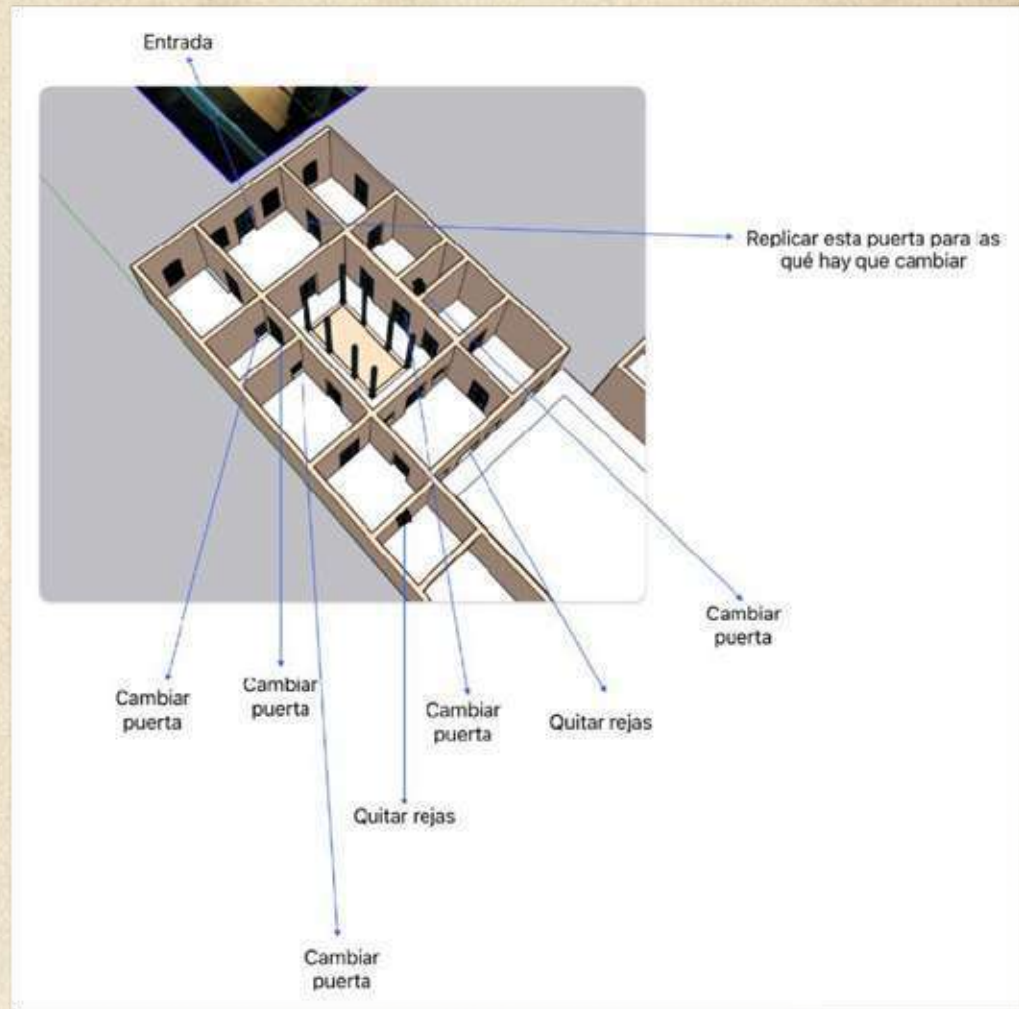
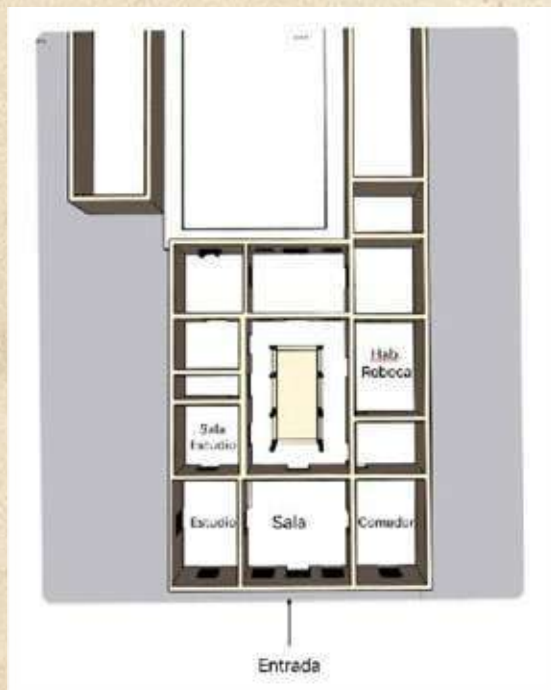
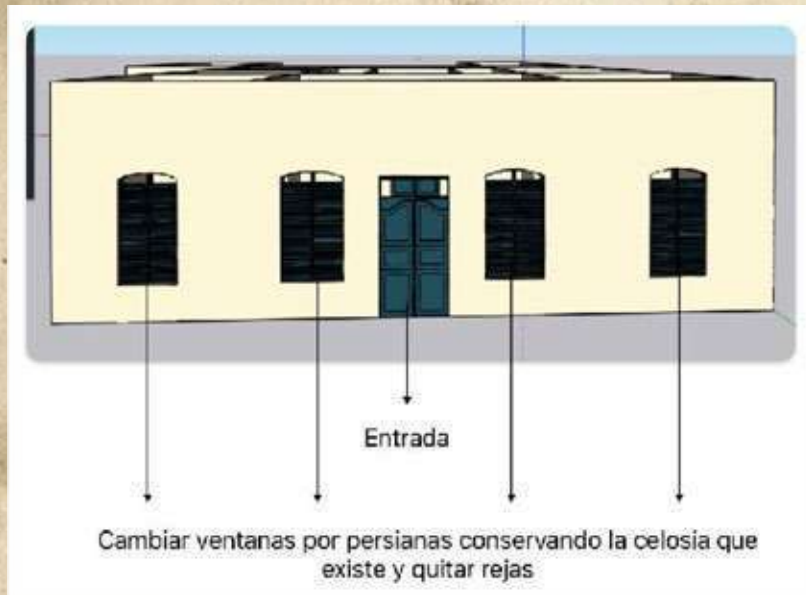

ONE HUNDRED YEARS OF SOLITUDE

MOSCOTE HOUSE LOCATION



ONE HUNDRED
YEARS OF SOLITUDE

MOSCOTE HOUSE
LOCATION DRESSING & PARTIAL BUILD



ONE HUNDRED
YEARS OF SOLITUDE

MOSCOTE HOUSE
LOCATION DRESSING & PARTIAL BUILD



ONE HUNDRED
YEARS OF SOLITUDE

MOSCOTE HOUSE
LOCATION DRESSING & PARTIAL BUILD



ONE HUNDRED
YEARS OF SOLITUDE

MOSCOTE HOUSE
MOSCOTE FAMILY PORTRAITS



**ONE HUNDRED
YEARS OF SOLITUDE**

**MOSCOTE HOUSE
LOCATION DRESSING & PARTIAL BUILD**



ONE HUNDRED
YEARS OF SOLITUDE

MOSCOTE HOUSE
LOCATION DRESSING & PARTIAL BUILD



STIL



STIL

**ONE HUNDRED
YEARS OF SOLITUDE**

**MOSCOTE HOUSE
LOCATION DRESSING & PARTIAL BUILD**



STIL



STIL



**ONE HUNDRED
YEARS OF SOLITUDE**

MARKET



ONE HUNDRED
YEARS OF SOLITUDE

RENDER
MARKET





ONE HUNDRED
YEARS OF SOLITUDE

RENDERO
MARKET



ONE HUNDRED YEARS OF SOLITUDE

BACKLOT BUILD MARKET - BUILDING PROCESS



ONE HUNDRED
YEARS OF SOLITUDE

STILLS
MARKET



ONE HUNDRED YEARS OF SOLITUDE

STILS MARKET



ONE HUNDRED
YEARS OF SOLITUDE

BACKLOT BUILD
MARKET - FINISHED SET



ONE HUNDRED
YEARS OF SOLITUDE

BACKLOT BUILD
MARKET - FINISHED SET



ONE HUNDRED
YEARS OF SOLITUDE

BACKLOT BUILD
MARKET - FINISHED SET



ONE HUNDRED YEARS OF SOLITUDE

BACKLOT BUILD MARKET - FINISHED SET



ONE HUNDRED
YEARS OF SOLITUDE

GRAPHICS
MARKET

ALMACEN del DIA
ABARROTES

PRECIOS FIJOS ARTICULOS AMERICANOS AGENCIA GENERAL
Y DEL PAIS DE VIVERES

FABRICA DE AGUARDIENTE

COLOMO
E HIJO



ONE HUNDRED YEARS OF SOLITUDE

GRAPHICS MARKET

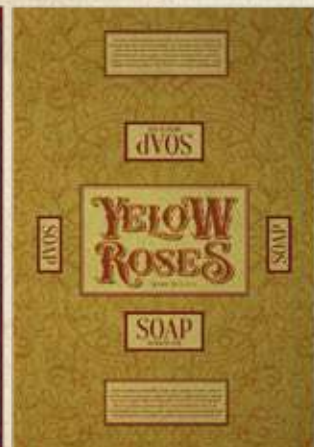
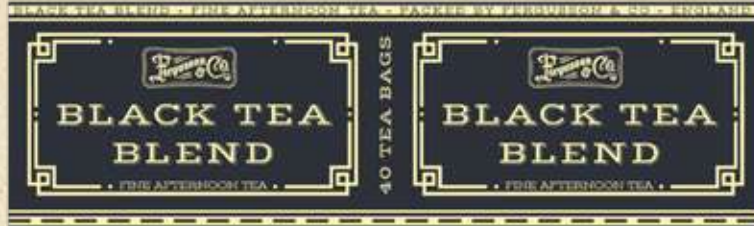

ONE HUNDRED
YEARS OF SOLITUDE

STILS
MARKET





**ONE HUNDRED
YEARS OF SOLTUDE**

MUNICIPAL SCHOOL



ONE HUNDRED
YEARS OF SOLITUDE

MACONDO 4
MUNICIPAL SCHOOL 4TH STAGE (1885)



**ONE HUNDRED
YEARS OF SOLITUDE**

MACONDO 4
MUNICIPAL SCHOOL 4TH STAGE (1885)



ONE HUNDRED YEARS OF SOLITUDE

STAGE BUILD MUNICIPAL SCHOOL 4TH STAGE (1885)



**ONE HUNDRED
YEARS OF SOLITUDE**

STAGE BUILD
MUNICIPAL SCHOOL 4TH STAGE (1885)



**ONE HUNDRED
YEARS OF SOLITUDE**

FACADE COLOR CHANGE
MUNICIPAL SCHOOL 4TH STAGE (1885)



**ONE HUNDRED
YEARS OF SOLITUDE**

FACADE COLOR CHANGE
MUNICIPAL SCHOOL 4TH STAGE (1885)



**ONE HUNDRED
YEARS OF SOLITUDE**

FACADE COLOR CHANGE
MUNICIPAL SCHOOL 4TH STAGE (1885)



**ONE HUNDRED
YEARS OF SOLITUDE**

BACKLOT BUILD
MUNICIPAL SCHOOL 4TH STAGE (1885)



**ONE HUNDRED
YEARS OF SOLITUDE**

BACKLOT BUILD
MUNICIPAL SCHOOL 4TH STAGE (1885)



ONE HUNDRED YEARS OF SOLITUDE

GRAPHICS MUNICIPAL SCHOOL 4TH STAGE (1885)



**ONE HUNDRED
YEARS OF SOLITUDE**

MILITARY BARRACKS
MUNICIPAL SCHOOL 4TH STAGE (1885)



**ONE HUNDRED
YEARS OF SOLITUDE**

**MILITARY BARRACKS
MUNICIPAL SCHOOL 4TH STAGE (1885)**





**ONE HUNDRED
YEARS OF SOLITUDE**

PIETRO CRESPI'S



ONE HUNDRED
YEARS OF SOLITUDE

CONCEPT ARTWORK
PIETRO CRESPI'S SHOP



Temporada 1 - Calle de los Turcos (foto de campo) - Bucena 7/17



Temporada 1 - Tienda Pietro Crespi (p. 10), Escena 5-49

ONE HUNDRED
YEARS OF SOLITUDE

RENDERO
PIETRO CRESPI'S SHOP



ONE HUNDRED YEARS OF SOLITUDE

BACKLOT BUILD

PIETRO CRESPI'S SHOP

ELEVATIONS & ISOMETRIC VIEWS

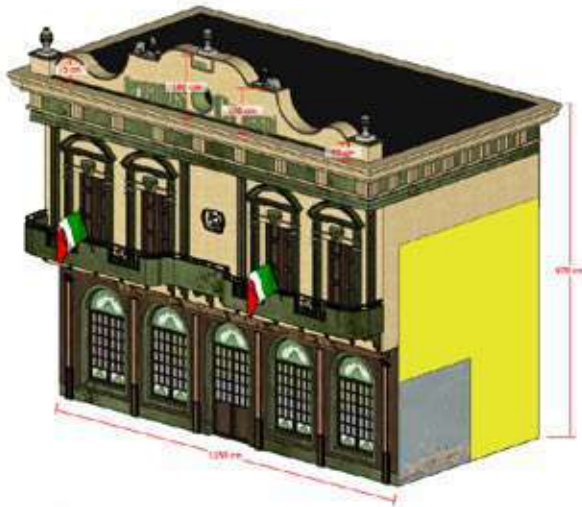

1 AXONOMETRIA
ZONA 12 - CASA 13 PIETRO CRESPI ESC: 1/75

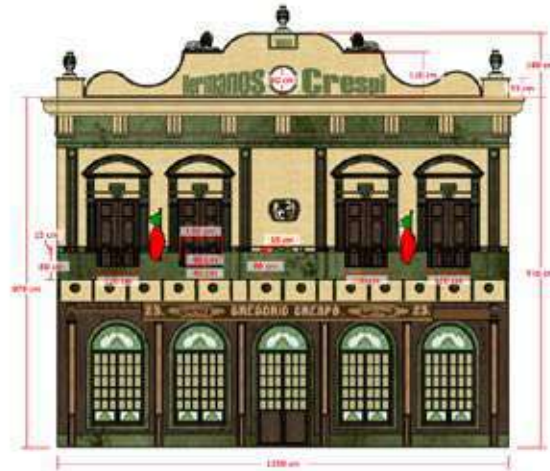

2 ALZADO FRONTAL
ZONA 12 - CASA 13 PIETRO CRESPI ESC: 1/75



3 PLANTA PRIMER NIVEL
ZONA 12 - CASA 13 PIETRO CRESPI ESC: 1/75



4 PLANTA SEGUNDO NIVEL
ZONA 12 - CASA 13 PIETRO CRESPI ESC: 1/75

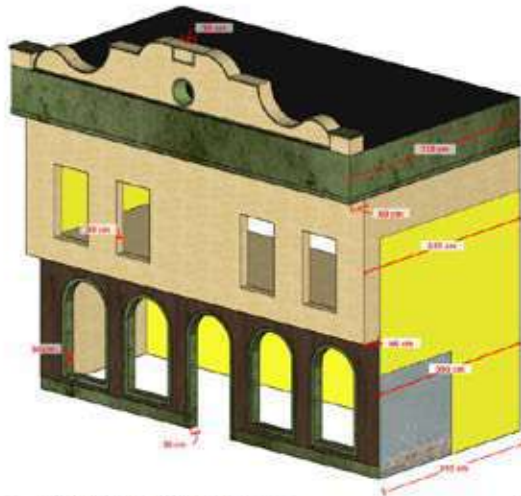

5 AXONOMETRIA BASTIDOR
ZONA 12 - CASA 13 PIETRO CRESPI ESC: 1/75

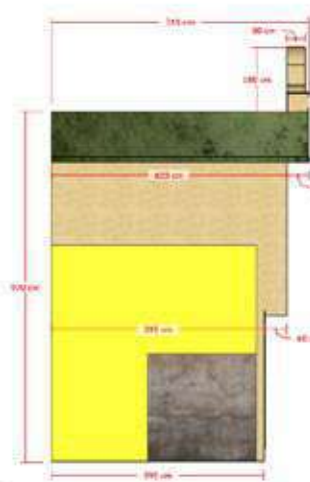

6 BASTIDOR IZQUIERDO
ZONA 12 - CASA 13 PIETRO CRESPI ESC: 1/75

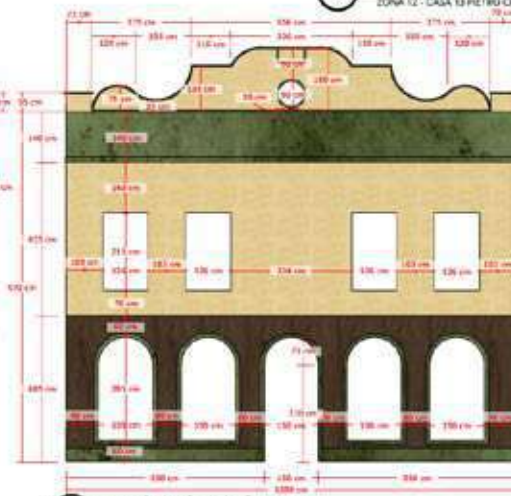

7 BASTIDOR FRONTAL
ZONA 12 - CASA 13 PIETRO CRESPI ESC: 1/75

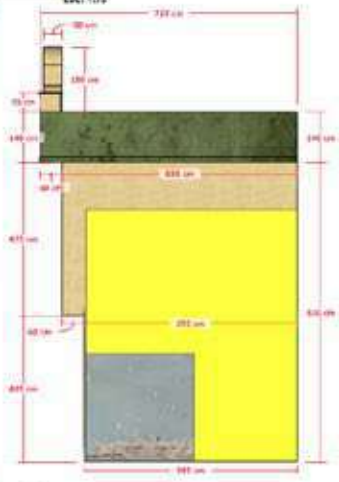

8 BASTIDOR DERECHO
ZONA 12 - CASA 13 PIETRO CRESPI ESC: 1/75

ONE HUNDRED YEARS OF SOLITUDE

BACKLOT BUILD PIETRO CRESPI'S SHOP - DETAILS

ZONA 12-CASA 13

PUERTA -1 1UND

① Z12-C13-P1 TOP
ESC: 1:20

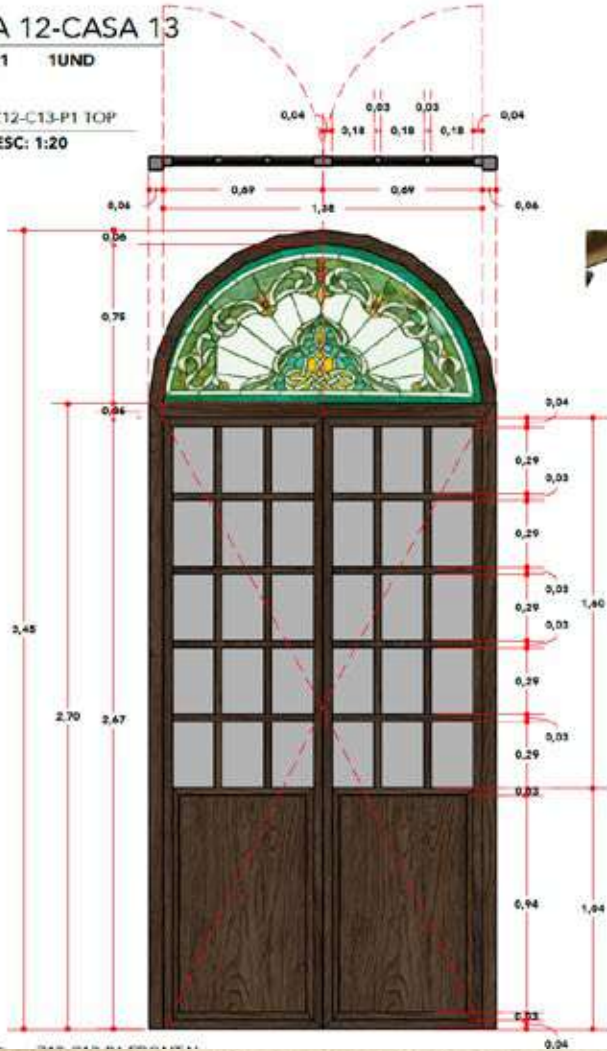

ZONA 12-CASA 13

VENTANA -1 4UND

③ Z12-C13-V1 TOP
ESC: 1:20



④ Z12-C13-V1 FRONTAL
ESC: 1:20

ONE HUNDRED
YEARS OF SOLITUDE

BACKLOT BUILD
PIETRO CRESPI'S SHOP - FINISHED SET



ONE HUNDRED
YEARS OF SOLITUDE

BACKLOT BUILD
PIETRO CRESPI'S SHOP - FINISHED SET



ONE HUNDRED
YEARS OF SOLITUDE

BACKLOT BUILD
PIETRO CRESPI'S SHOP - FINISHED SET



ONE HUNDRED
YEARS OF SOLITUDE

BACKLOT BUILD
PIETRO CRESPI'S SHOP - GRAPHICS



ONE HUNDRED
YEARS OF SOLITUDE

BACKLOT BUILD
PIETRO CRESPI'S SHOP - GRAPHICS
STAINED GLASS WINDOWS

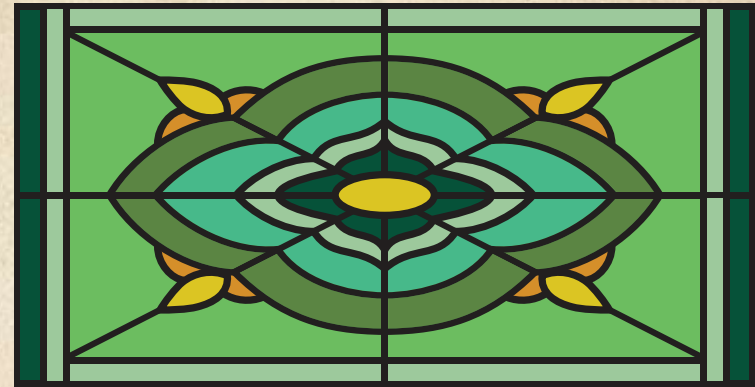

ONE HUNDRED
YEARS OF SOLITUDE

BACKLOT BUILD
PIETRO CRESPI'S SHOP - FINISHED SET



ONE HUNDRED
YEARS OF SOLITUDE

STILLS
PIETRO CRESPI'S OFFICE



ONE HUNDRED YEARS OF SOLITUDE

LOCATION BUILD

PIETRO CRESPI'S OFFICE

PARTIAL BUILD & DRESSING

LOCATION



FINISHED SET



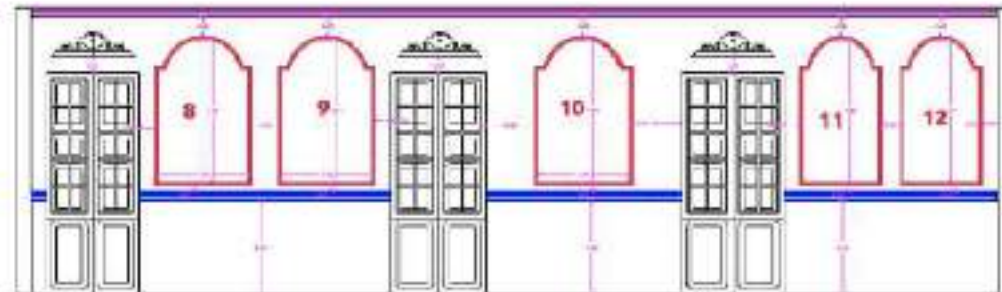
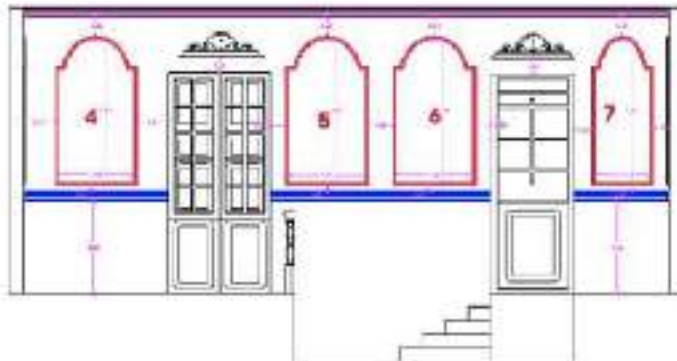
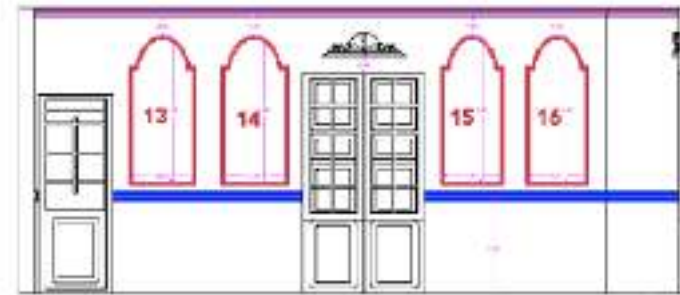
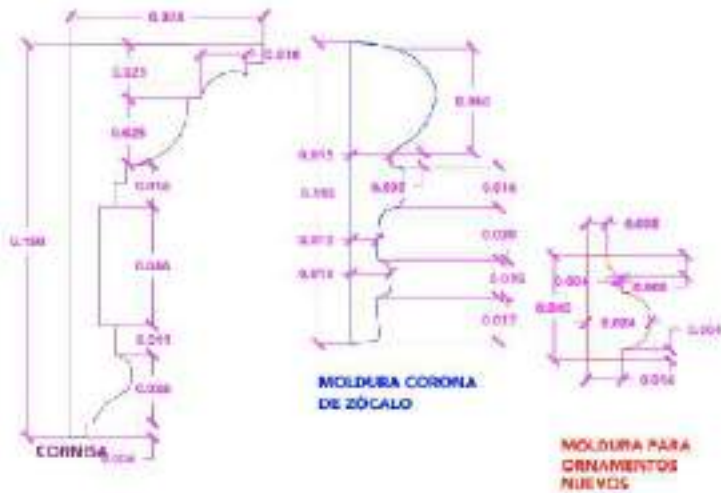

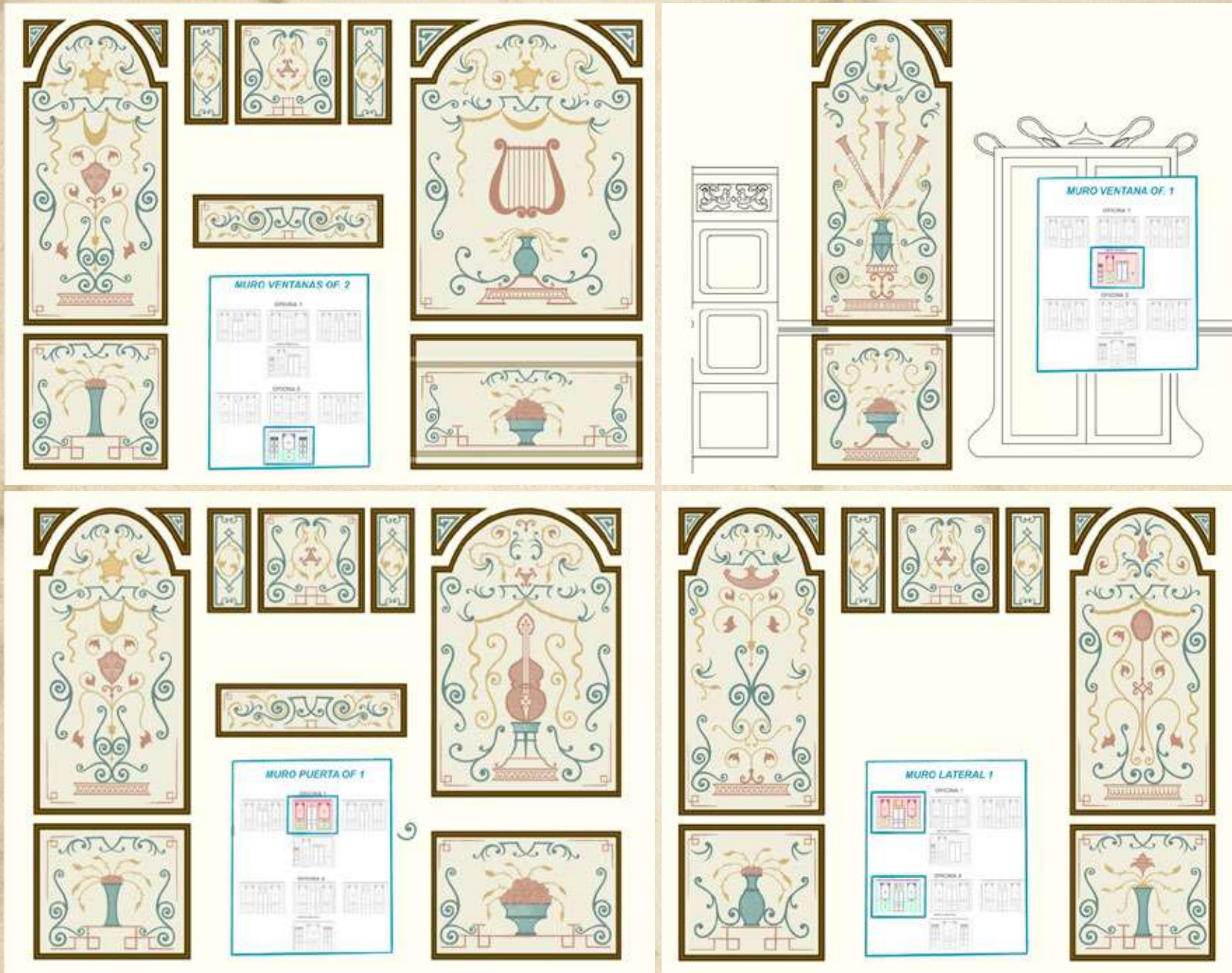



**ONE HUNDRED
YEARS OF SOLITUDE**

TURKS STREET



ONE HUNDRED
YEARS OF SOLITUDE

CONCEPT ARTWORK
TURKS STREET



Temporada - Calle de los Turcos (últ. a izquierda), Escena 7/17

ONE HUNDRED YEARS OF SOLITUDE

RENDERS & FINISHED SETS TURKS STREET



RENDER



FINISHED SET



FINISHED SET



RENDER

ONE HUNDRED
YEARS OF SOLITUDE

RENDERS & FINISHED SETS
TURKS STREET



RENDER



FINISHED SET

ONE HUNDRED YEARS OF SOLITUDE

BACKLOT BUILD TURKS STREET - LAYOUT PLANS

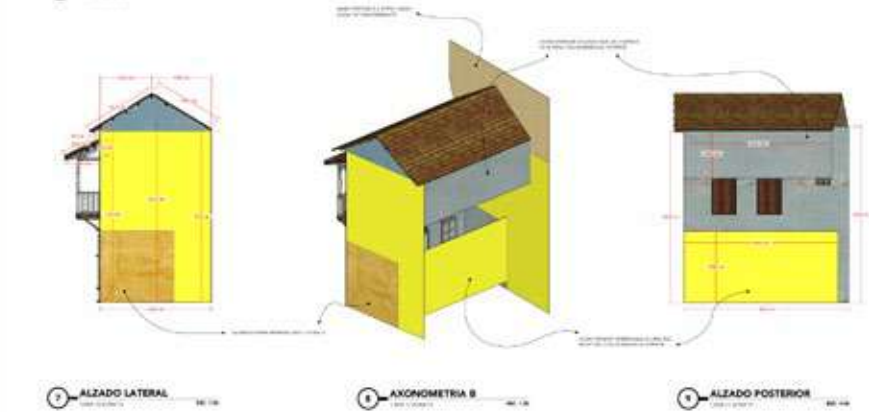
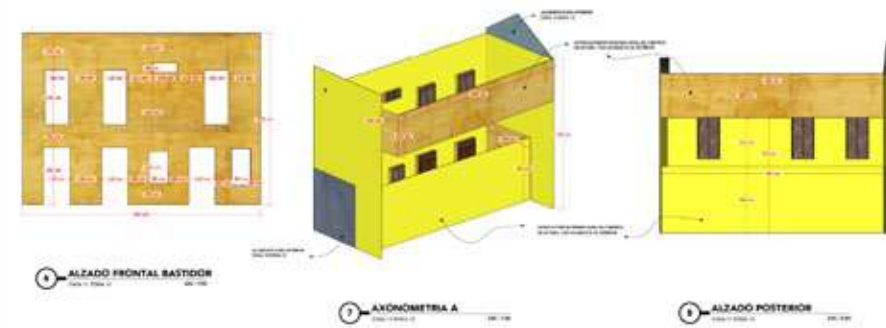
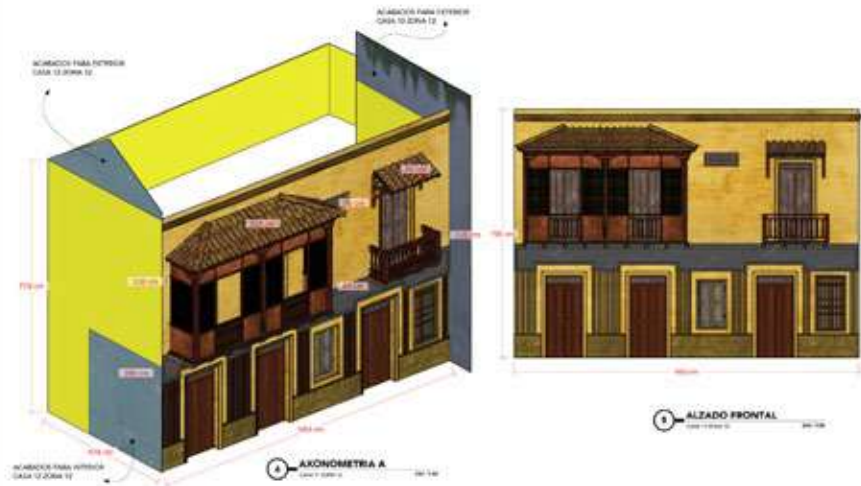
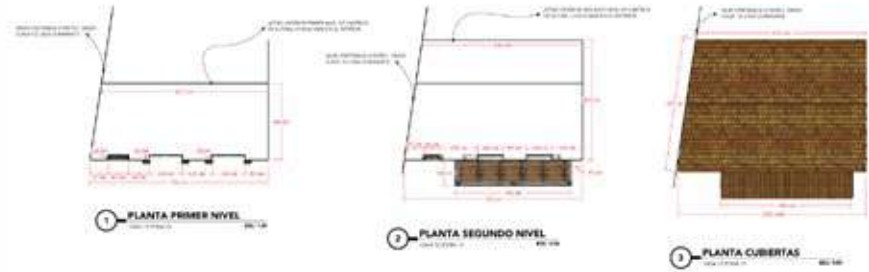

ONE HUNDRED YEARS OF SOLITUDE

BACKLOT BUILD TURKS STREET - LAYOUT PLANS

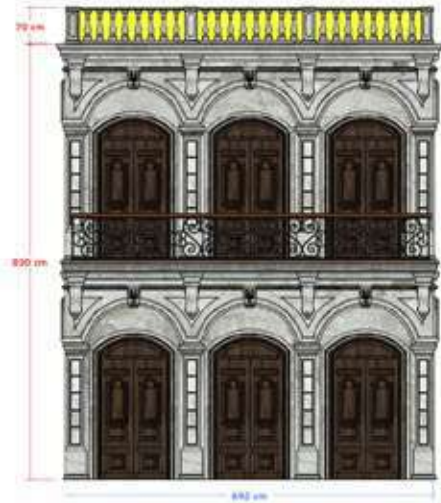

1 ALZADO FRONTAL
CASA 9 - ZONA 12
ESC. 1:30

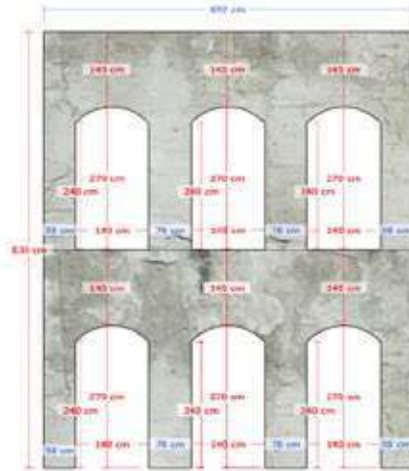

2 ALZADO FRONTAL BASTIDOR
CASA 9 - ZONA 12
ESC. 1:30

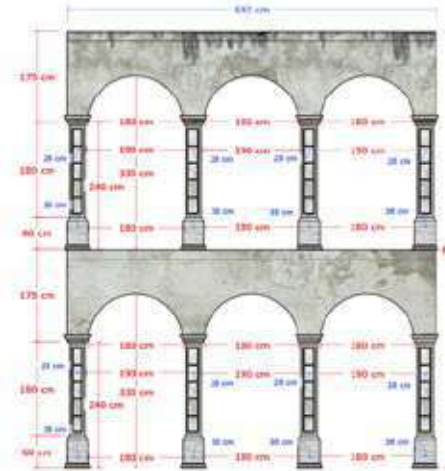

3 ALZADO FRONTAL ARCADEA Y COLUMNAS
CASA 9 - ZONA 12
ESC. 1:30

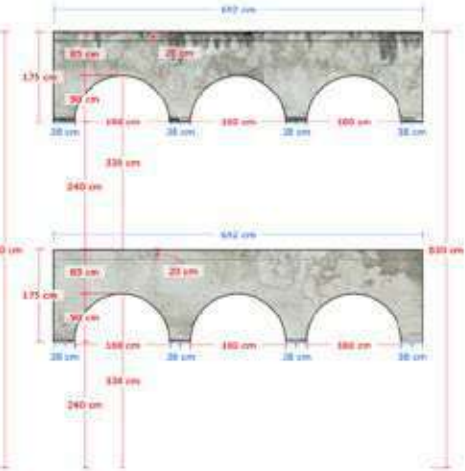

4 ALZADO FRONTAL ARCADEA
CASA 9 - ZONA 12
ESC. 1:30

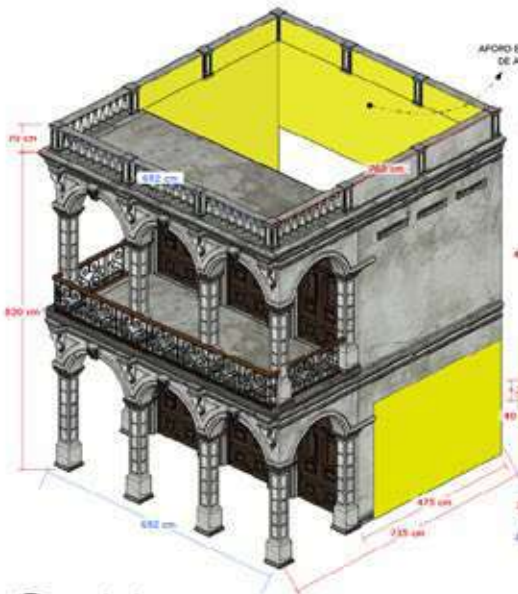

5 AXONOMETRIA A
CASA 9 - ZONA 12
ESC. 1:40

AFORO EXTERIOR SEGUNDO NIVEL DE 2.4 METROS DE ALTURA, CON ACABADOS AL EXTERIOR

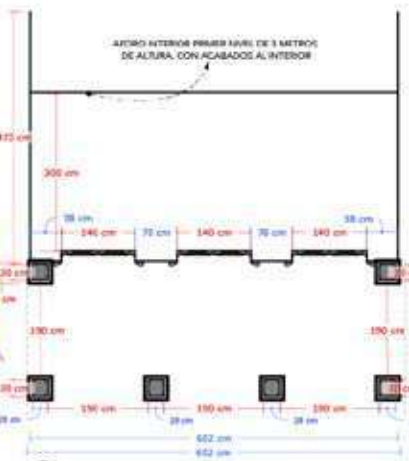

6 PLANTA PRIMER NIVEL
CASA 9 - ZONA 12
ESC. 1:50

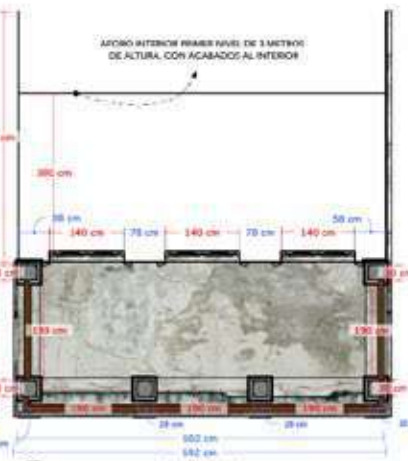

7 PLANTA SEGUNDO NIVEL
CASA 9 - ZONA 12
ESC. 1:50



8 PLANTA CUBIERTA
CASA 9 - ZONA 12
ESC. 1:50

ONE HUNDRED
YEARS OF SOLITUDE

BACKLOT BUILD
TURKS STREET - BUILDING PROCESS



ONE HUNDRED
YEARS OF SOLITUDE

BACKLOT BUILD
TURKS STREET - BUILDING PROCESS



ONE HUNDRED
YEARS OF SOLITUDE

STILLS
TURKS STREET



ONE HUNDRED
YEARS OF SOLITUDE

FINISHED SETS
TURKS STREET





ONE HUNDRED
YEARS OF SOLITUDE

FINISHED SETS
TURKS STREET



ONE HUNDRED YEARS OF SOLITUDE

FINISHED SETS TURKS STREET



ONE HUNDRED
YEARS OF SOLITUDE

GRAPHICS
TURKS STREET

GRANERO

F. Barroso

Precios Fijos

VENTA
DE
SAL

DULCES FINOS

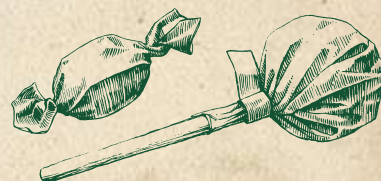

ANDRES CARRERA SALAZAR

FERRETERIA

SOMBROS
SUAZAS

REINA & MORENO

ONE HUNDRED
YEARS OF SOLITUDE

GRAPHICS
TURKS STREET

TABAQUERIA

BERNAL

LO
MEJOR
QUE SE
FUMA

CIGARRILLOS

GRAN
FABRICA
DE
TABACO

EBANISTERIA
MARCEILLE HNOS.

Nazar-Kuri & Sfair



SE COMPRO Y
SE VENDE TODA
CLASE DE MADERA
ASERRADA
MADERA DE
CALIDAD

ONE HUNDRED
YEARS OF SOLITUDE

GRAPHICS
TURKS STREET

DUQUE & AMEZQUITA

IMPORTACION
DIRECTA
SURTIDO
RENOVADO
ARTICULOS
DE GUSTO

TELAS DE SEDA DE COLOR
AGUJAS DE CROCHET
PAÑOLONES
VARIAS CLASES
BORDADOS
BLANCOS
FINISIMOS



2 GENEROS
DE
HILO Y ALGODON
SEDAS JAPONESAS
OTOMANA TAFETAN
DE SEDA NEGRO Y
DE COLORES
HOLANES
BLANCOS DE PURO
NEGROS Y LINO
DE COLORES

MODA
RIVEROS
& FRANCO



PERFUMES
WITHINGHAM

Relojeria Legler

ROPA HECHA FINA PARA
SEÑORAS Y CABALLEROS
ARTICULOS DE MODA

ONE HUNDRED
YEARS OF SOLITUDE

GRAPHICS
TURKS STREET

ZAPATOS FAMILIA BARAJAS



Elixir de
RAIZ DE TOTUMO
*para el crecimiento
y belleza del*
CABELLO

**RECALZAMOS
LOS ZAPATOS**
de

**DAMA Y
GABALLERO**

**SALON
de PELUQUERIA**

ONE HUNDRED
YEARS OF SOLITUDE

STILS
TÜRKS STREET





**ONE HUNDRED
YEARS OF SOLITUDE**

CATARINO'S SALOON



ONE HUNDRED
YEARS OF SOLITUDE

CONCEPT ARTWORK
CATARINO'S SALOON



Temporada 1 - Tienda de Catarino, escena 5-44

ONE HUNDRED
YEARS OF SOLITUDE

CONCEPT ARTWORK
CATARINO'S SALOON



Temporada e plaza de Macondo vista de Catarino Catarino

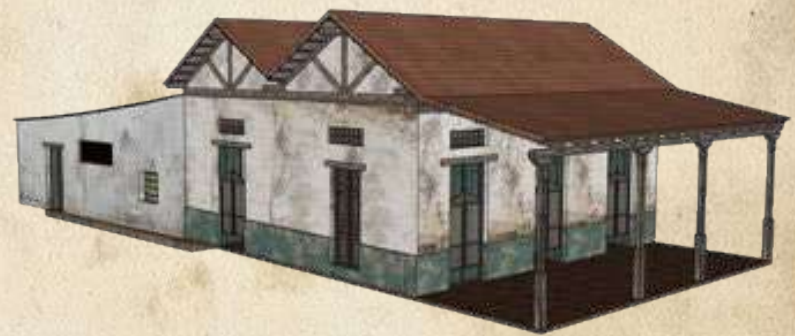

ONE HUNDRED
YEARS OF SOLITUDE

RENDERS
CATARINO'S SALOON



2 CATARINO-ZONA-9/CASA-8
PLANTA BAJA ESC. 1:50

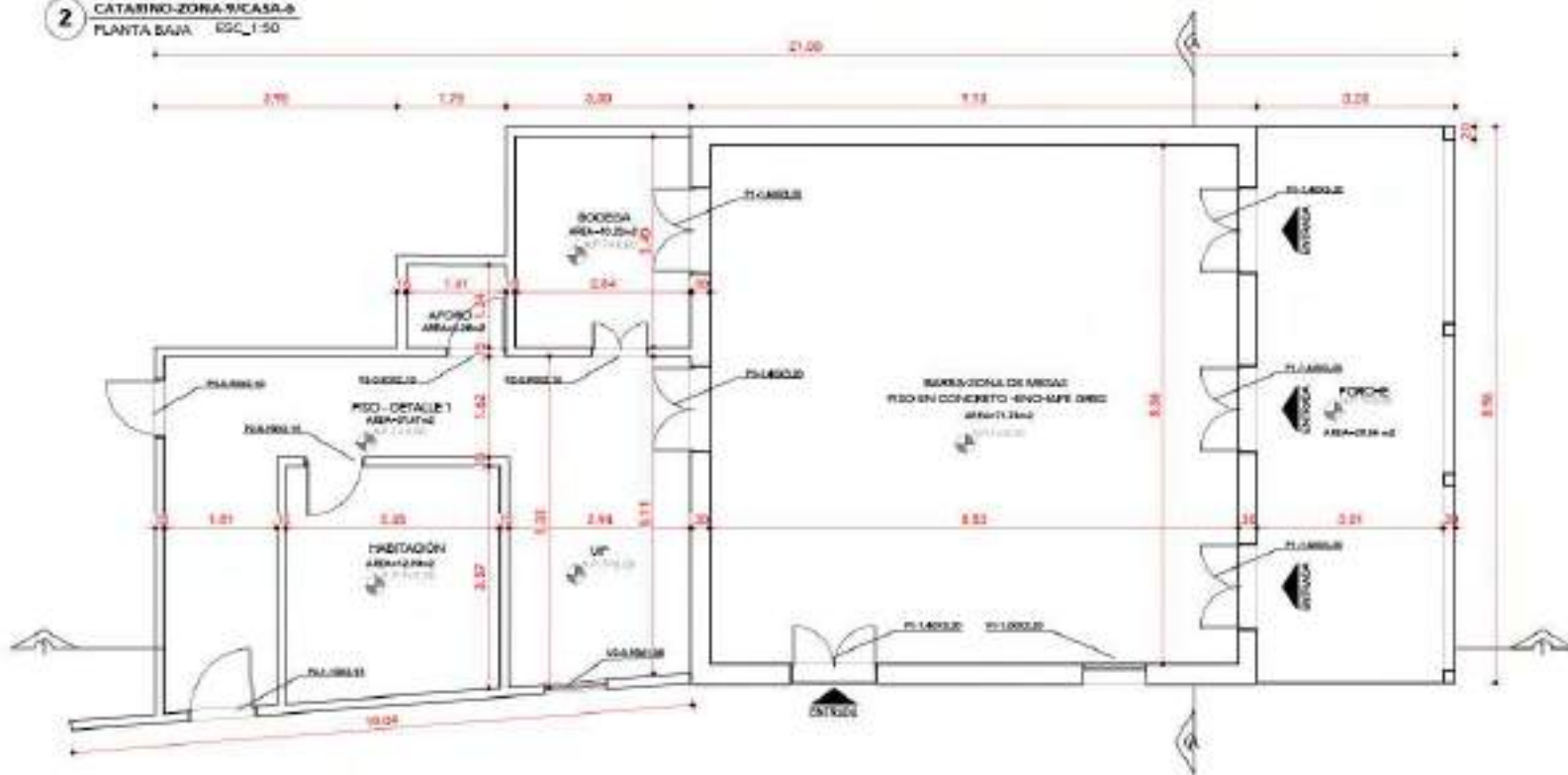

3 CATARINO-ZONA-9/CASA-8
SECCIÓN 1-1 ESC. 1:75

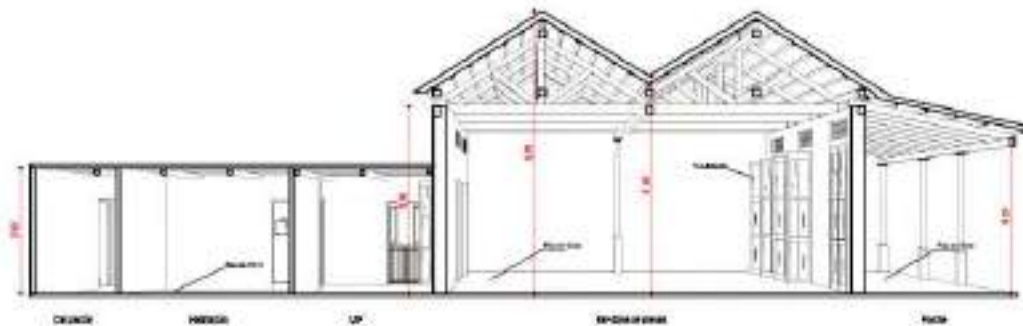

4 CATARINO-ZONA-9/CASA-8
SECCIÓN A-A ESC. 1:75



ONE HUNDRED YEARS OF SOLITUDE

BACKLOT BUILD CATARINO'S SALOON - LAYOUT PLANS

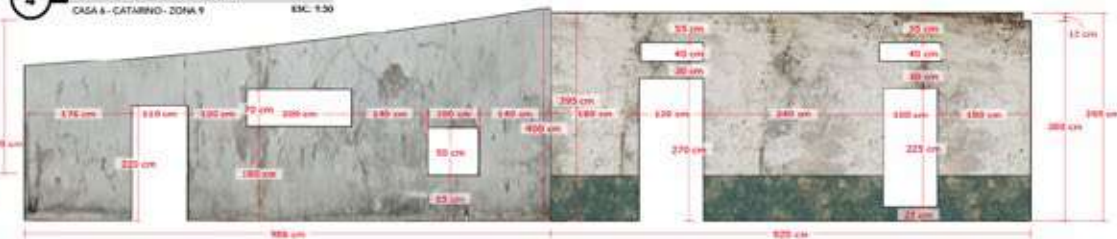
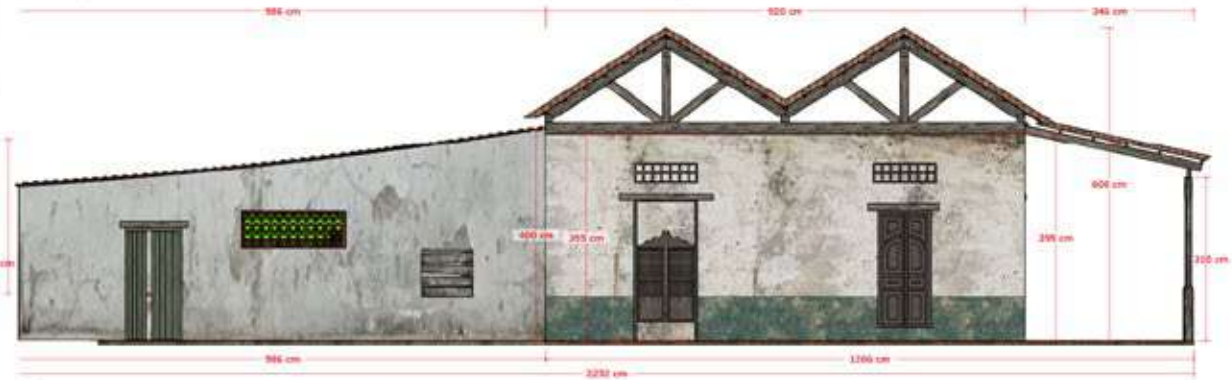
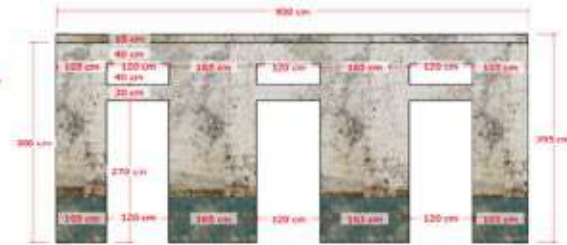
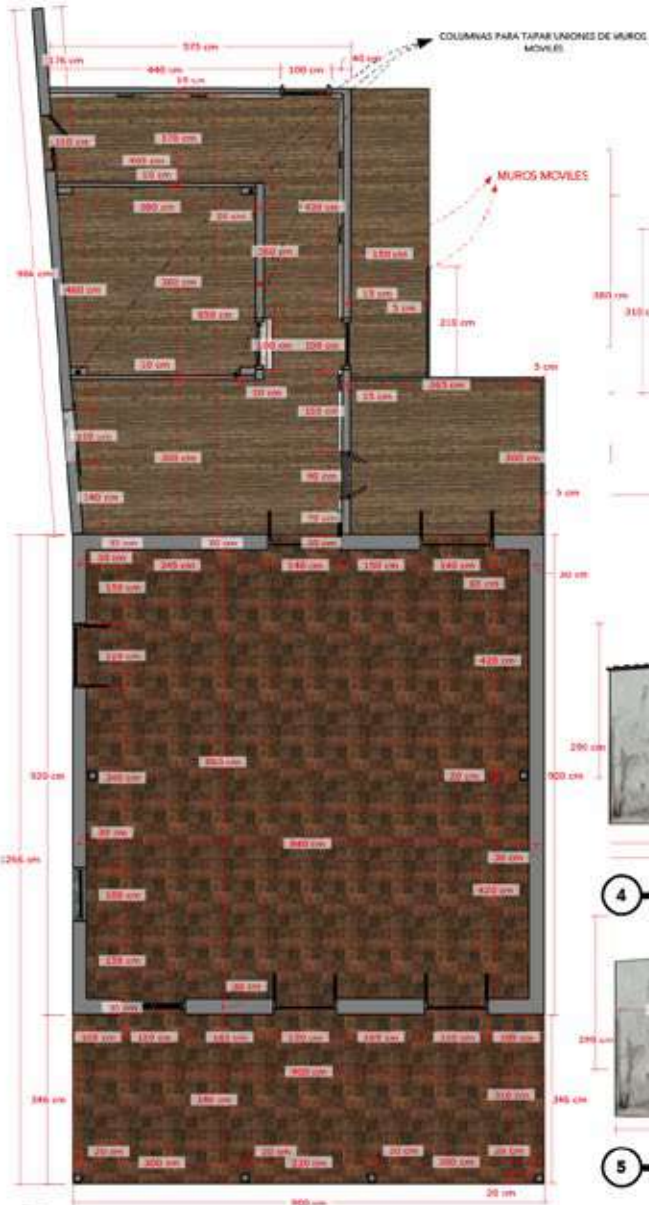

1 M4 CIELORASO CATARINO-PERSPECTIVA
MACONDO 4 ZONAS_CASAA

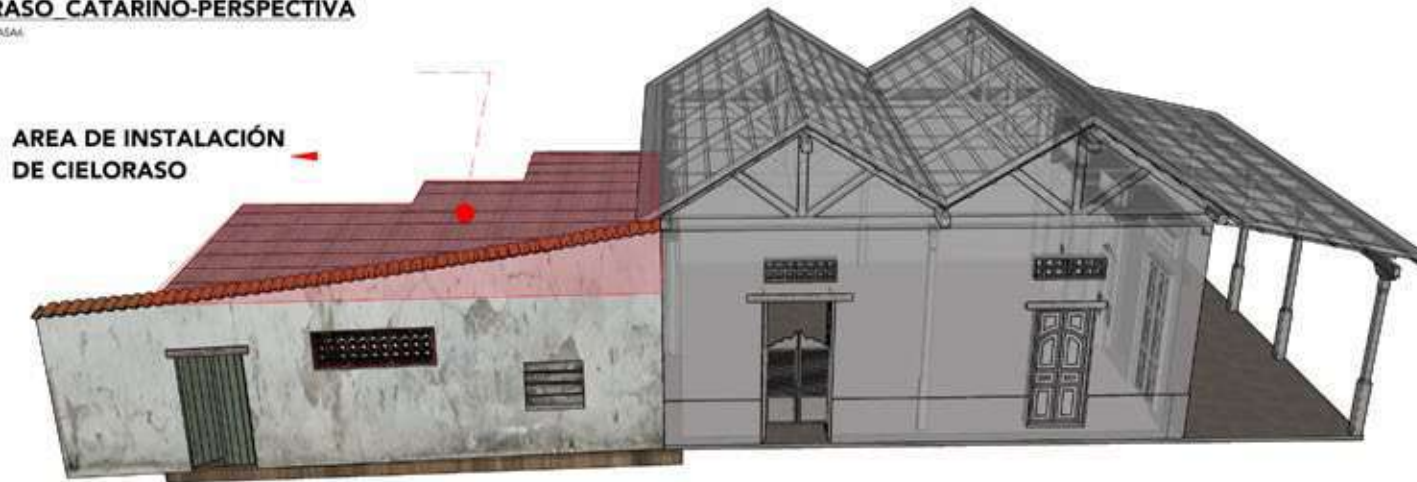

2 PLANTA GENERAL CIELORASO
M4 ZONAS_CASAA

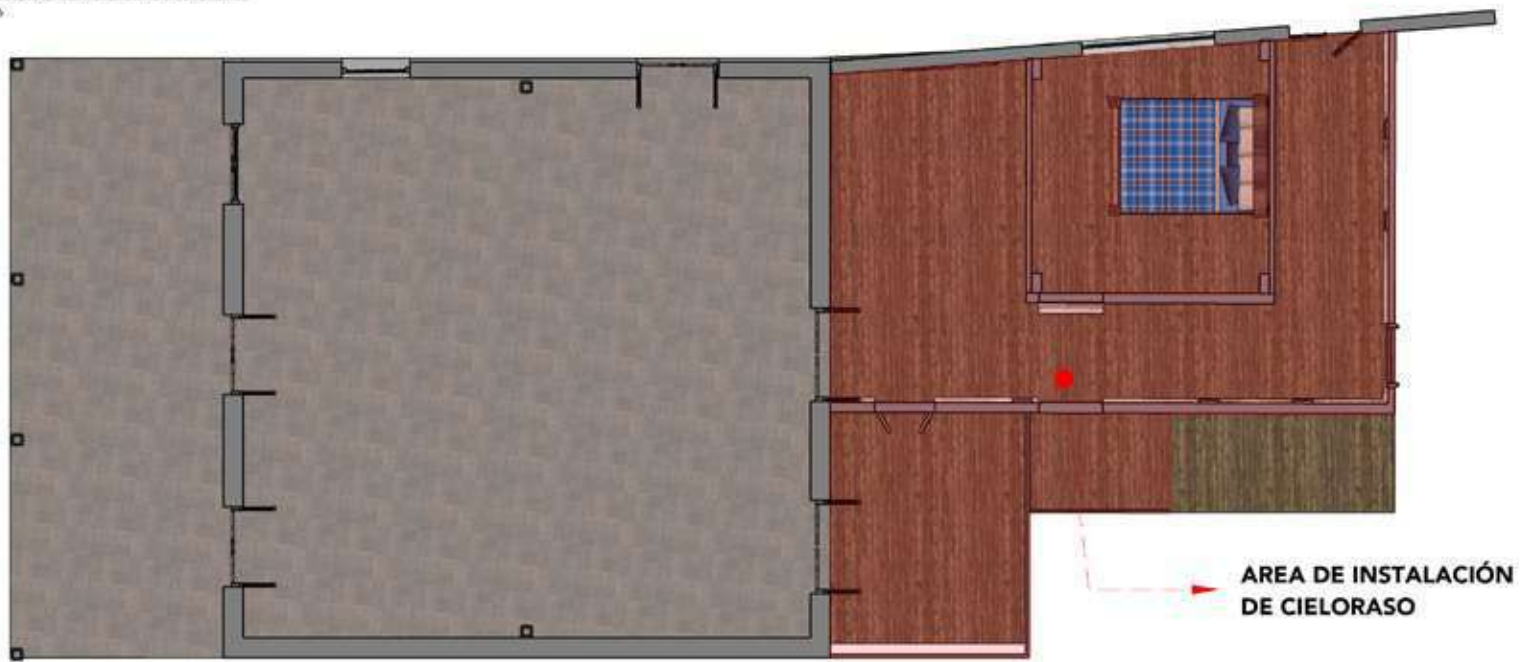

**ONE HUNDRED
YEARS OF SOLITUDE**

**BACKLOT BUILD
CATARINO'S SALOON - BUILDING PROCESS**



ONE HUNDRED
YEARS OF SOLITUDE

STILS
CATARINO'S SALOON



ONE HUNDRED
YEARS OF SOLITUDE

STILS
CATARINO'S SALOON



ONE HUNDRED
YEARS OF SOLITUDE

FINISHED SET
CATARINO'S SALOON



ONE HUNDRED
YEARS OF SOLITUDE

GRAPHICS
CATARINO'S SALOON

CATARINO

SANTA MARTA

FABRICA DE AGUARDIENTE COLONO & HIJO

FABRICA DE LICORES

FABRICA DE LICORES

FABRICA DE AGUARDIENTE
COLONO
&
HIJO
NETO 35 1/2 V.
11-55-50
153 M
MAGONDO

DESTILERIA DEL MAGDALENA
RON
NEQUE
PERMISO No
ENVASADO EN
47 1/2 V.
7-1-5-11-426 M



ONE HUNDRED
YEARS OF SOLITUDE

FINISHED SET
CATARINO'S SALOON



ONE HUNDRED
YEARS OF SOLITUDE

FINISHED SET
CATARINO'S SALOON





**ONE HUNDRED
YEARS OF SOLITUDE**

NOGUERA PHARMACY





**ONE HUNDRED
YEARS OF SOLITUDE**

MACONDO'S CHURCH



**ONE HUNDRED
YEARS OF SOLITUDE**

MACONDO 4 BACKLOT FACADE BUILD / LOCATION MATCHING
MACONDO'S CHURCH



**ONE HUNDRED
YEARS OF SOLITUDE**

MACONDO 4 BACKLOT FACADE BUILD / LOCATION MATCHING
MACONDO'S CHURCH



ONE HUNDRED YEARS OF SOLITUDE

MACONDO 4 BACKLOT BUILD / KEY PLAN VIEW / ISOMETRIC VIEW

MACONDO'S CHURCH

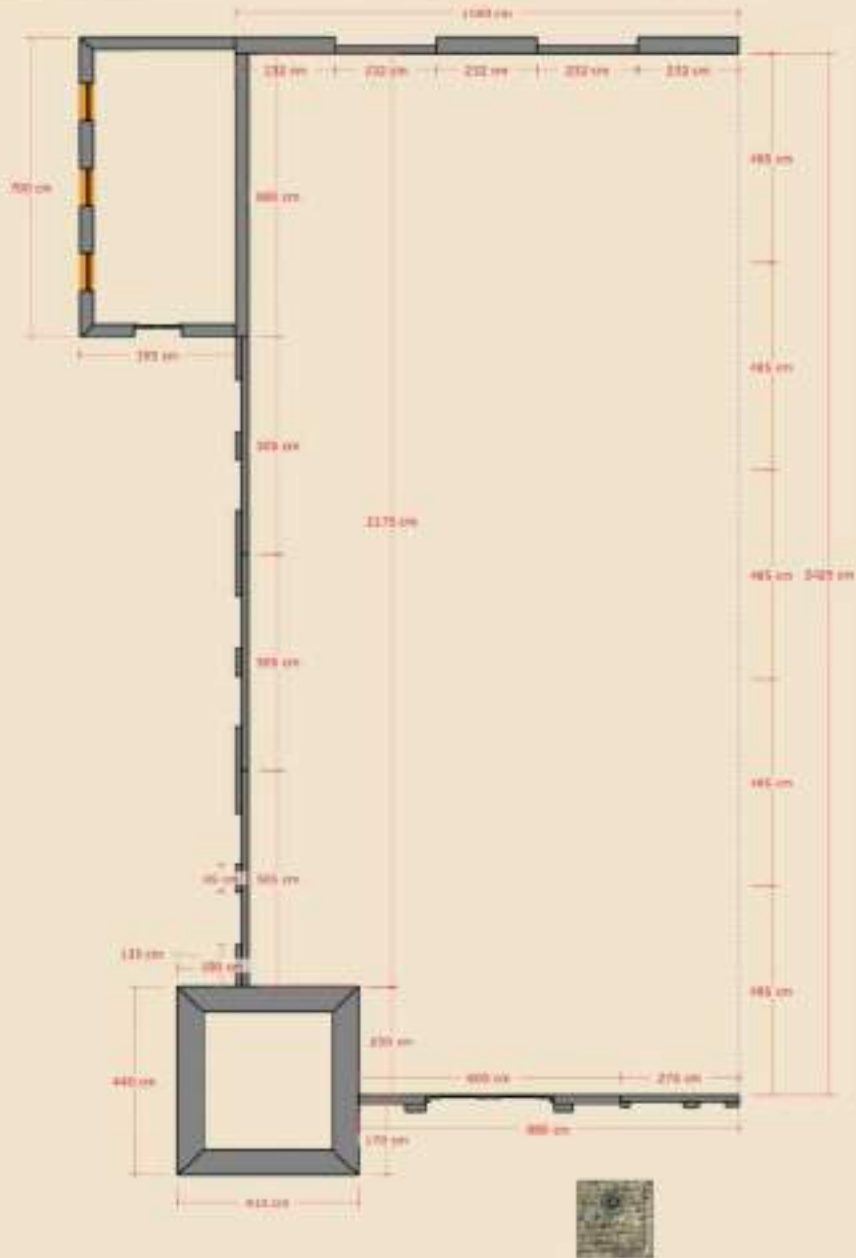

2 AXONOMETRIA
CHURCH
SEC. 1-160

**ONE HUNDRED
YEARS OF SOLITUDE**

BUILDING TIMELINE CONCEPT ARTWORK
MACONDO'S CHURCH



**ONE HUNDRED
YEARS OF SOLITUDE**

BUILDING TIMELINE CONCEPT ARTWORK
MACONDO'S CHURCH



**ONE HUNDRED
YEARS OF SOLITUDE**

BUILDING TIMELINE CONCEPT ARTWORK
MACONDO'S CHURCH



**ONE HUNDRED
YEARS OF SOLITUDE**

BUILDING TIMELINE CONCEPT ARTWORK
MACONDO'S CHURCH



**ONE HUNDRED
YEARS OF SOLITUDE**

TIMELINE VIEWS
MACONDO'S CHURCH



**ONE HUNDRED
YEARS OF SOLITUDE**

TIMELINE VIEWS
MACONDO'S CHURCH



**ONE HUNDRED
YEARS OF SOLITUDE**

TIMELINE VIEWS
MACONDO'S CHURCH



**ONE HUNDRED
YEARS OF SOLITUDE**

TIMELINE VIEWS
MACONDO'S CHURCH



**ONE HUNDRED
YEARS OF SOLITUDE**

TIMELINE VIEWS
MACONDO'S CHURCH



**ONE HUNDRED
YEARS OF SOLITUDE**

TIMELINE VIEWS
MACONDO'S CHURCH



**ONE HUNDRED
YEARS OF SOLITUDE**

MACONDO 4 BACKLOT BUILD
MACONDO'S CHURCH



**ONE HUNDRED
YEARS OF SOLITUDE**

MACONDO 4 BACKLOT BUILD
MACONDO'S CHURCH



**ONE HUNDRED
YEARS OF SOLITUDE**

MACONDO 4 BACKLOT BUILD / TIMELINE REVAMPS
MACONDO'S CHURCH



**ONE HUNDRED
YEARS OF SOLITUDE**

MACONDO 4 BACKLOT BUILD / FINISHED SET

MACONDO'S CHURCH



**ONE HUNDRED
YEARS OF SOLITUDE**

LOCATION, PARTIAL BUILD & DRESSING
MACONDO'S CHURCH



**ONE HUNDRED
YEARS OF SOLITUDE**

LOCATION, PARTIAL BUILD & DRESSING
MACONDO'S CHURCH



**ONE HUNDRED
YEARS OF SOLITUDE**

LOCATION BUILD PROCESS
MACONDO'S CHURCH



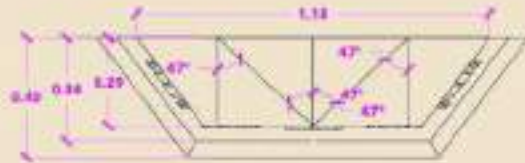

VISTA SUPERIOR

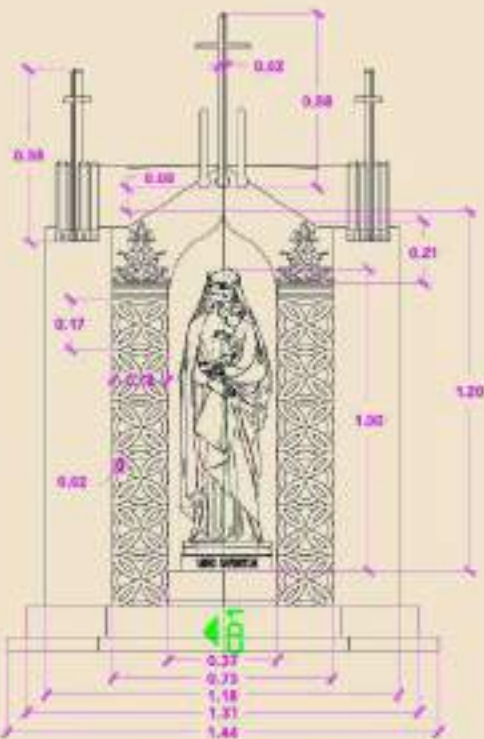

VISTA FRONTAL

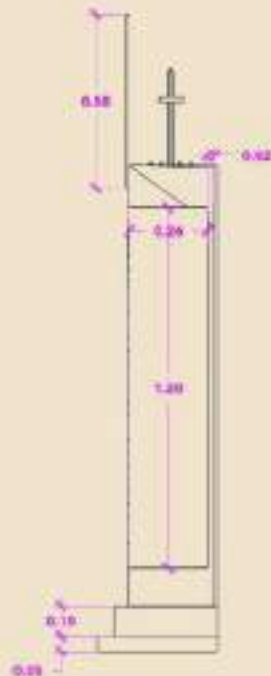
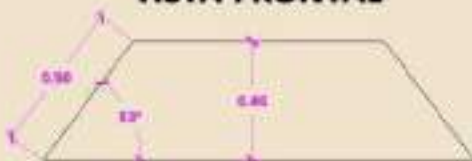

CORTE DETALLE 1



DETALLES DE RETABLOS

ONE HUNDRED YEARS OF SOLITUDE

LOCATION

MACONDO'S CHURCH



**ONE HUNDRED
YEARS OF SOLITUDE**

LOCATION PROCESS
MACONDO'S CHURCH



ONE HUNDRED YEARS OF SOLITUDE

LOCATION PROCESS
MACONDO'S CHURCH



**ONE HUNDRED
YEARS OF SOLITUDE**

LOCATION PROCESS
MACONDO'S CHURCH



**ONE HUNDRED
YEARS OF SOLITUDE**

LOCATION PROCESS
MACONDO'S CHURCH



**ONE HUNDRED
YEARS OF SOLITUDE**

LOCATION PARTIAL BUILD & DRESSING
MACONDO'S CHURCH



**ONE HUNDRED
YEARS OF SOLITUDE**

LOCATION PARTIAL BUILD & DRESSING
MACONDO'S CHURCH



**ONE HUNDRED
YEARS OF SOLITUDE**

LOCATION PARTIAL BUILD & DRESSING

MACONDO'S CHURCH

